

**DIRECTIVE 2014/35/EU, ANNEX I**  
**PESO(Principal Elements of the Safety Objectives) for electrical equipment designed for use within certain voltage limits**

**Reference No**.....: 22CE-RY2-PESO(0)

**Manufacturer's Name** .....: Kun Hung Electric Co., Ltd.

**Address**.....: 183, Hancheon-ro, Dongdaemun-gu, Seoul, 02534 Rep. of Korea

**Analyzing location**.....: Same as manufacturer

**Subcontractor (laboratory)** .....: LDNS Co., Ltd.

**Address**.....: Rm.#902, 118, LS-ro 116beon-gil, Dongan-gu, Anyang-si, Gyeonggi-do, 14118 Republic of Korea

**Applied Regulation** .....: Directive 2014/35/EU, Annex I

**Type of test object** .....: Relay Socket

**Trademark**.....: 

**Model reference**.....: 1) KH-RS-H4CS 2) KH-RS-H4C 3) KH-TDR-R8  
 4) KH-RS-R11 5) KH-RS-R8

**Factory's Name & Address** .....: Same as manufacturer

**Ratings**.....: 10 A, AC 250 V

**TCF Reference Number**.....: KTR-22CE-80(0)

Rev. No.	Revised Contents	Prepared by	Reviewed by	Approved by	Revision date
0	1 <sup>st</sup> edition of PESO checklist	-	-		September 1, 2022
1					
2					
3					
4					
5					

	ANNEX I – Principal Elements of the Safety Objectives	Applicable? ?	Evidence with Description	Verdict
---	---	------------------	---------------------------	---------

## ■ Contents ■

1.	General conditions .....	3
2.	Protection against hazards arising from the electrical equipment .....	3
3.	Protection against hazards which may be caused by external influences on the electrical equipment .....	4
Appendix A	Certificate of Manufacturing Quality .....	5

	ANNEX I – Principal Elements of the Safety Objectives	Applicable ?	Evidence with Description	Verdict
---	---	--------------	---------------------------	---------

## 1. General conditions

<p>(a) <i>the essential characteristics, the recognition and observance of which will ensure that electrical equipment will be used safely and in applications for which it was made, shall be marked on the electrical equipment, or, if this is not possible, on an accompanying document;</i></p>	Yes	See the rating label and the Leaflet (Ver.1.0).	P
--	-----	---	---

Remarks: None.

<p>(b) <i>the electrical equipment, together with its component parts, shall be made in such a way as to ensure that it can be safely and properly assembled and connected;</i></p>	Yes	<p>1) See the test reports of EN 61984 (LR-22-C008(0)).</p> <p>2) See Appendix A for Certificate of ISO 9001.</p>	P
---	-----	---	---

Remarks: None.

<p>(c) <i>the electrical equipment shall be so designed and manufactured as to ensure that protection against the hazards set out in points 2 and 3 is assured, providing that the equipment is used in applications for which it was made and is adequately maintained.</i></p>	Yes	See points 2 and 3.	P
--	-----	---------------------	---

Remarks: None.

## 2. Protection against hazards arising from the electrical equipment

<p><i>Measures of a technical nature shall be laid down in accordance with point 1, in order to ensure that:</i></p> <p>(a) <i>persons and domestic animals are adequately protected against the danger of physical injury or other harm which might be caused by direct or indirect contact;</i></p>	Yes	<p>1) See the risk assessment document 22CE-RY2-RA(0).</p> <p>2) See the test report of EN 61984 (LR-22-C008(0)).</p>	P
---	-----	---	---

Remarks: None.

<p>(b) <i>temperatures, arcs or radiation which would cause a danger, are not produced;</i></p>	Yes	<p>1) See the risk assessment document 22CE-RY2-RA(0).</p> <p>2) See the test report of EN 61984 (LR-22-C008(0)).</p>	P
---	-----	---	---

Remarks: None.

<p>(c) <i>persons, domestic animals and property are adequately protected against non-electrical dangers caused by the electrical equipment which</i></p>	Yes	<p>1) See the risk assessment document 22CE-RY2-RA(0).</p> <p>2) See the test report of EN</p>	P
---	-----	--	---

KOINOX	ANNEX I – Principal Elements of the Safety Objectives	Applicable ?	Evidence with Description	Verdict
--------	---	--------------	---------------------------	---------

<i>are revealed by experience;</i>		61984 (LR-22-C008(0)).	
------------------------------------	--	------------------------	--

Remarks: None.

<i>(d) the insulation is suitable for foreseeable conditions.</i>	Yes	1) See the risk assessment document 22CE-RY2-RA(0). 2) See the test report of EN 61984 (LR-22-C008(0)).	P
---	-----	--	---

Remarks: None.

### 3. Protection against hazards which may be caused by external influences on the electrical equipment

<p><i>Technical measures shall be laid down in accordance with point 1, in order to ensure that the electrical equipment:</i></p> <p><i>(a) meets the expected mechanical requirements in such a way that persons, domestic animals and property are not endangered;</i></p>	Yes	1) See the Leaflet (Ver.1.0). 2) See the risk assessment document 22CE-RY2-RA(0). 3) See the test report of EN 61984 (LR-22-C008(0)).	P
--	-----	---	---

Remarks: This Relay Socket is installed and enclosed in an electric cabinet with the aim to relay or distribute electronic signal or electric power supply within the control circuit in such a way to protect persons, domestic animals and property.

<i>(b) is resistant to non-mechanical influences in expected environmental conditions, in such a way that persons, domestic animals and property are not endangered;</i>	Yes	1) See the Leaflet (Ver.1.0). 2) See the risk assessment document 22CE-RY2-RA(0). 3) See the test report of EN 61984 (LR-22-C008(0)).	P
--	-----	---	---

Remarks: None.

<i>(c) does not endanger persons, domestic animals and property in foreseeable conditions of overload. EN L 96/368 Official Journal of the European Union 29.3.2014</i>	Yes	1) See the Leaflet (Ver.1.0). 2) See the risk assessment document 22CE-RY2-RA(0). 3) See the test report of EN 61984 (LR-22-C008(0)).	P
---	-----	---	---

Remarks: None.



## 2.2 RISK Assessment Report



### Tool description for general risk assessment

**1. Severity of harm: S**

- 1) **S1** slight injury (usually reversible), for example, scratches, laceration, bruising, light wound requiring first aid).
- 2) **S2** serious injury (usually irreversible, including fatality), for example, broken or torn-out or crushed limbs, fractures, serious injuries requiring stitches, major musculoskeletal troubles (MST), fatalities.

**2. Frequency and/or duration of exposure to hazard: F**

- 1) **F1** twice or less per work shift or less than 15 min cumulated exposure per work shift.
- 2) **F2** more than twice per work shift or more than 15 min cumulated exposure per work shift.

**3. Probability of occurrence of the hazardous event: O**

- 1) **O1** mature technology, proven and recognized in safety application; robustness.
- 2) **O2** technical failure observed in the two last years:
  - inappropriate human action by a well-trained person aware of the risks and having more than six months experience on the workstation.
- 3) **O3** technical failure regularly observed (every six months or less):
  - inappropriate human action by an untrained person having less than six months experience on the workstation.
  - similar accident observed in the plant in the preceding ten years.

**4. Possibility of avoidance or reduction of harm: A**

- 1) **A1** possible under some conditions:
  - if parts move at a speed less than 0,25 m/s AND the exposed worker is familiar with the risks and with the indications of a hazardous situation or impending hazardous event.
  - depending on particular conditions (temperature, noise, ergonomics, etc.).
- 2) **A2** impossible.

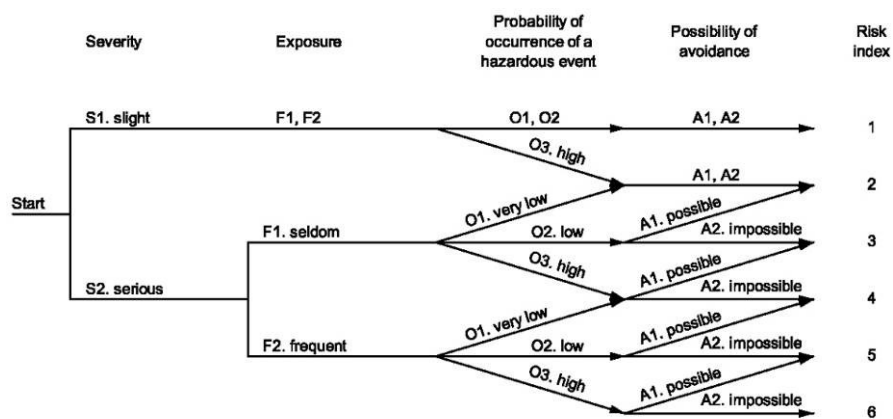

Risk graph for risk estimation

**5. Risk index**

- 1) 1 or 2: lowest priority of action (priority 3) - broadly acceptable zone: ■
- 2) 3 or 4: medium priority of action (priority 2) – zone as low as reasonably practicable: ■
- 3) 5 or 6: highest priority of action (priority 1) - intolerable zone: ■

S: Severity	A: Avoidance	C: Applicable? (N: No, Y: Yes)	J: Risk reduction
F: Frequency	RI: Risk Index	H: Risk estimation (initial risk)	K: Risk estimation (after risk reduction)
O: Occurrence			L: Further solution required?

## Annex C – Risk assessment documents against hazards, hazardous situations, and hazardous events

### 1. Electrical hazards

Hazards	Caused by	Hazardous situations	Hazardous events	G	H				K				L			
					S	F	O	A	RI	S	F	O		A	RI	
a. Leakage current				N												
b. energy supply				N												
c. Stored charges				N												
d. arcs				N												
Remark: 1) Since the polycarbonate case that has passed the 750 °C glow wire test and 125 °C ball pressure test is used, the effect of the arcs generated at each contact is recognized to be insignificant.																
e. electric shock				N												
Remark: 1) Since it is assumed that the relay socket enclosed by a plastic enclosure is generally placed on the designated relay socket and mounted on a DIN rail in an electrical cabinet, electric shock is not foreseen in a normal use. 2) Installation mentioned above is described in the leaflet (Ver.1.0).																
f. burns				N												
g. Ingressive water protection				N												
h. Insulation distance		h1. insulation breakdown	h1. electric shock or relay damage	Y	2	1	2	2	3	1h1R1. Reinforced insulation implemented	2	1	1	2	2	No
Remark: 1) See the figure in Appendix A. 2) Assume that the relay is generally installed in an electrical cabinet with a pollution degree of II rather than III.																

S: Severity	A: Avoidance	G: Applicable? (N: No, Y: Yes)	J: Risk reduction
F: Frequency	RI: Risk Index	H: Risk estimation (initial risk)	K: Risk estimation (after risk reduction)
O: Occurrence			L: Further solution required?

Hazards	Caused by	Hazardous situations	Hazardous events	G	H			K			L			
					S	F	O	S	F	O				
					A	A	RI	A	A	RI				
i. Electrical endurance	i1. Low level of robustness	i1. Continuous use of the relay, not knowing life span	i1. Damage of the relay or surrounding devices	Y	2	1	2	2	3	1	1	2	2	No
														1) 10 number of electrical endurance test performed with the relay of KH-103-H4C. 2) Since the number of accesses per year is less than 10, the risk due to electrical endurance is not foreseen.

## 2. Mechanical hazards

Hazards	Caused by	Hazardous situations	Hazardous events	G	H			K			L			
					S	F	O	S	F	O				
					A	A	RI	A	A	RI				
a. Instability				N										
b. break-down during operation				N										
c. falling or ejected objects				N										
d. inadequate surfaces, edges, or corners	d1. Sharp corner	d1. Serviceman touchable	d1. Shearing on a hand	Y	1	1	3	2	2	1	1	1	1	No
														1) The touchable parts are examined in the final inspection of production.
Remark: None														
e. moving parts, especially where there may be variations in the rotational speed of parts				N										
f. vibration				N										
g. improper fitting of parts	g1. Complicacy by 4-pole change over contacts with coil wiring	g1. Wiring to a wrong terminal	g1. Relay socket damaged by a short circuit or over voltage	Y	2	2	3	1	5	1	2	1	2	No
														1) The identification number of each terminal is embossed near the one. 2) The leaflet recommends using a dedicated

S: Severity	A: Avoidance	C: Applicable? (N: No, Y: Yes)	J: Risk reduction
F: Frequency	RI: Risk Index	H: Risk estimation (initial risk)	K: Risk estimation (after risk reduction)
O: Occurrence			L: Further solution required?

Hazards	Caused by	Hazardous situations	Hazardous events	G	H			K			L			
					S	F	O	A	RI	S		F	O	A
<b>Remark:</b> 1) See the Photos in Appendix B for the identification number and its layout.														
i. Mechanical endurance		i1. Continuous use of the relay socket, not knowing life span	i1. Damage of the relay or surrounding devices	Y	2	1	2	2	3	1	1	2	2	No
<b>Remark:</b> None														

### 3. Explosion

Hazards	Caused by	Hazardous situations	Hazardous events	G	H			K			L			
					S	F	O	A	RI	S		F	O	A
a.				N										
<b>Remark:</b> 1) Explosion hazards are not foreseen to be happened.														

### 4. Hazards arising from electric, magnetic, and electromagnetic fields, other ionizing and non-ionizing radiation

Hazards	Caused by	Hazardous situations	Hazardous events	G	H			K			L			
					S	F	O	A	RI	S		F	O	A
a.				N										
<b>Remark:</b> 1) Radiation hazards are not foreseen to be happened.														

### 5. Electric, magnetic, and electromagnetic disturbances

Hazards	Caused by	Hazardous situations	Hazardous events	G	H			K			L			
					S	F	O	A	RI	S		F	O	A
a.				N										
<b>Remark:</b>														



S: Severity	A: Avoidance	G: Applicable? (N: No, Y: Yes)	J: Risk reduction
F: Frequency	RI: Risk Index	H: Risk estimation (initial risk)	K: Risk estimation (after risk reduction)
O: Occurrence			L: Further solution required?

Hazards	Caused by	Hazardous situations	Hazardous events	G	H			K			L	
					S	F	O	A	RI	S		F
a.				N								
<b>Remark:</b>												
1) Hazards arising from acoustic noise are not foreseen to be happened.												

### 10. Biological and chemical effects

Hazards	Caused by	Hazardous situations	Hazardous events	G	H			K			L	
					S	F	O	A	RI	S		F
a.				N								
<b>Remark:</b>												
1) Hazards from biological and chemical effects are not foreseen to be happened.												

### 11. Emissions, production and/or use of hazardous substances (e.g. gases, liquids, dusts, mists, vapour)

Hazards	Caused by	Hazardous situations	Hazardous events	G	H			K			L	
					S	F	O	A	RI	S		F
a.				N								
<b>Remark:</b>												
1) Hazards concerned with emissions, production and/or use of hazardous substances are not foreseen to be happened.												

### 12. Unattended operation

Hazards	Caused by	Hazardous situations	Hazardous events	G	H			K			L	
					S	F	O	A	RI	S		F
a.				N								
<b>Remark:</b>												
1) Hazards concerned with unattended operation should be inspected in the end-product.												

### 13. Connection to and interruption from power supply

Hazards	Caused by	Hazardous situations	Hazardous events	G	H			K			L	
					S	F	O	A	RI	S		F
<b>Remark:</b>												
1) Hazards concerned with unattended operation should be inspected in the end-product.												



S: Severity  
 F: Frequency  
 O: Occurrence

A: Avoidance  
 RI: Risk Index

C: Applicable? (N: No, Y: Yes)  
 H: Risk estimation (initial risk)

J: Risk reduction  
 K: Risk estimation (after risk reduction)  
 L: Further solution required?

Hazards	Caused by	Hazardous situations	Hazardous events	G	H			K			L	
					S	F	O	A	RI	S		F
a.				N								
<b>Remark:</b>												
1) Hazards concerned with connection to and interruption from power supply are not foreseen to be happened.												

#### 14. Combination of equipment

Hazards	Caused by	Hazardous situations	Hazardous events	G	H			K			L	
					S	F	O	A	RI	S		F
a.				N								
<b>Remark:</b>												
1) Hazards concerned with combination of equipment should be inspected in the end-product.												

#### 15. Implosion

Hazards	Caused by	Hazardous situations	Hazardous events	G	H			K			L	
					S	F	O	A	RI	S		F
a.				N								
<b>Remark:</b>												
1) Hazards concerned with implosion are not foreseen to be happened.												

#### 16. Hygiene conditions

Hazards	Caused by	Hazardous situations	Hazardous events	G	H			K			L	
					S	F	O	A	RI	S		F
a.				N								
<b>Remark:</b>												
1) Hazards concerned with hygiene conditions are not foreseen to be happened.												

#### 17. Ergonomics

Hazards	Caused by	Hazardous situations	Hazardous events	G	H			K			L	
					S	F	O	A	RI	S		F
<b>Remark:</b>												
1) Hazards concerned with ergonomics conditions are not foreseen to be happened.												

S: Severity  
 F: Frequency  
 O: Occurrence

A: Avoidance  
 RI: Risk Index

G: Applicable? (N: No, Y: Yes)  
 H: Risk estimation (initial risk)

J: Risk reduction  
 K: Risk estimation (after risk reduction)  
 L: Further solution required?

Hazards	Caused by	Hazardous situations	Hazardous events	G	H			K			L	
					S	F	O	A	RI	S		F
a.				N								
<b>Remark:</b>												
1) Hazards concerned with ergonomics are not foreseen to be happened.												

**18. Functional safety and reliability (Equipment design)**

Hazards	Caused by	Hazardous situations	Hazardous events	G	H			K			L	
					S	F	O	A	RI	S		F
a.				N								
<b>Remark:</b>												
1) Hazards concerned with functional safety and reliability should be inspected in the end-product.												

**19. Functional safety and reliability (Type related hazards)**

Hazards	Caused by	Hazardous situations	Hazardous events	G	H			K			L	
					S	F	O	A	RI	S		F
a.				N								
<b>Remark:</b>												
1) Hazards concerned with functional safety and reliability should be inspected in the end-product.												

**20. Functional safety and reliability (System faults)**

Hazards	Caused by	Hazardous situations	Hazardous events	G	H			K			L	
					S	F	O	A	RI	S		F
a.				N								
<b>Remark:</b>												
1) Hazards concerned with functional safety and reliability should be inspected in the end-product.												

**21. Casual or coincidental violation**

Hazards	Caused by	Hazardous situations	Hazardous events	G	H			K			L	
					S	F	O	A	RI	S		F
<b>Remark:</b>												
1) Hazards concerned with functional safety and reliability should be inspected in the end-product.												

S: Severity  
 F: Frequency  
 O: Occurrence

A: Avoidance  
 RI: Risk Index

C: Applicable? (N: No, Y: Yes)  
 H: Risk estimation (initial risk)

J: Risk reduction  
 K: Risk estimation (after risk reduction)  
 L: Further solution required?

Hazards	Caused by	Hazardous situations	Hazardous events	H			K			L				
				G	S	F	O	A	RI		S	F	O	A
a.			N											

**Remark:**  
 1) Hazards concerned with casual or coincidental violation are not foreseen to be happened.

**22. Intentional violation using simple means with low resources, generic skills and low motivation**

Hazards	Caused by	Hazardous situations	Hazardous events	H			K			L				
				G	S	F	O	A	RI		S	F	O	A
a.			N											

**Remark:**  
 1) Hazards concerned with intentional violation using simple means with low resources, generic skills and low motivation should be inspected in the end-product.

**23. Intentional violation using sophisticated means with moderate resources, specific skills related to the considered equipment and moderate motivation**

Hazards	Caused by	Hazardous situations	Hazardous events	H			K			L				
				G	S	F	O	A	RI		S	F	O	A
a.			N											

**Remark:**  
 1) Hazards concerned with intentional violation using sophisticated means with moderate resources, specific skills related to the considered equipment and moderate motivation should be inspected in the end-product.

**24. Intentional violation using sophisticated means with extended resources, specific skills related to the considered equipment and high motivation**

Hazards	Caused by	Hazardous situations	Hazardous events	H			K			L				
				G	S	F	O	A	RI		S	F	O	A
a.			N											

**Remark:**  
 1) Hazards intentional violation using sophisticated means with extended resources, specific skills related to the considered equipment and high motivation should be inspected in the end-product.



S: Severity	A: Avoidance	C: Applicable? (N: No, Y: Yes)	J: Risk reduction
F: Frequency	RI: Risk Index	H: Risk estimation (initial risk)	K: Risk estimation (after risk reduction)
O: Occurrence			L: Further solution required?

## 25. Information requirements

Hazards	Caused by	Hazardous situations	Hazardous events	G	H			K			L						
					S	F	O	A	RI	S		F	O	A	RI		
a. Hard to identify marking	Poor durability	Connector marking frequently touched by hands	Connection to an out-of-range power source	Y	2	1	2	2	3	No further action necessary, because analysis shows that, after initial installation, the likelihood of accessing the markings is very low.	2	1	1	2	2	No	<input checked="" type="checkbox"/>

**Remark:**

1) This analysis is related to the clause of 7.3.2 of EN 61984:2009.

2) Hazards concerned with information requirements are not foreseen to be happened.

## Appendix A Insulation distance

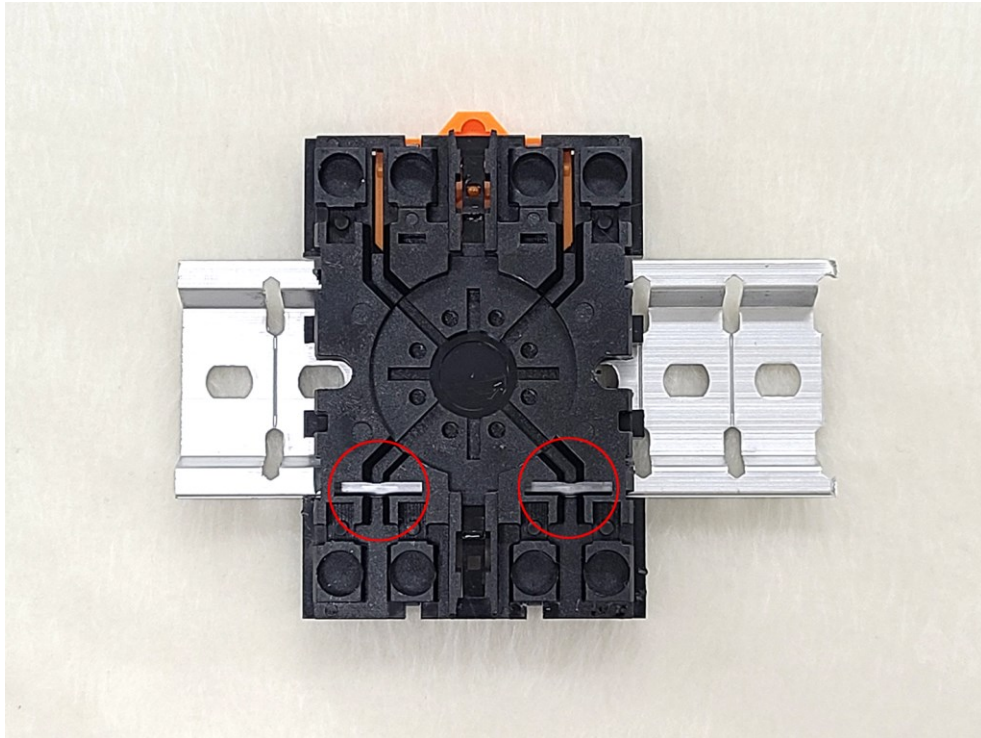

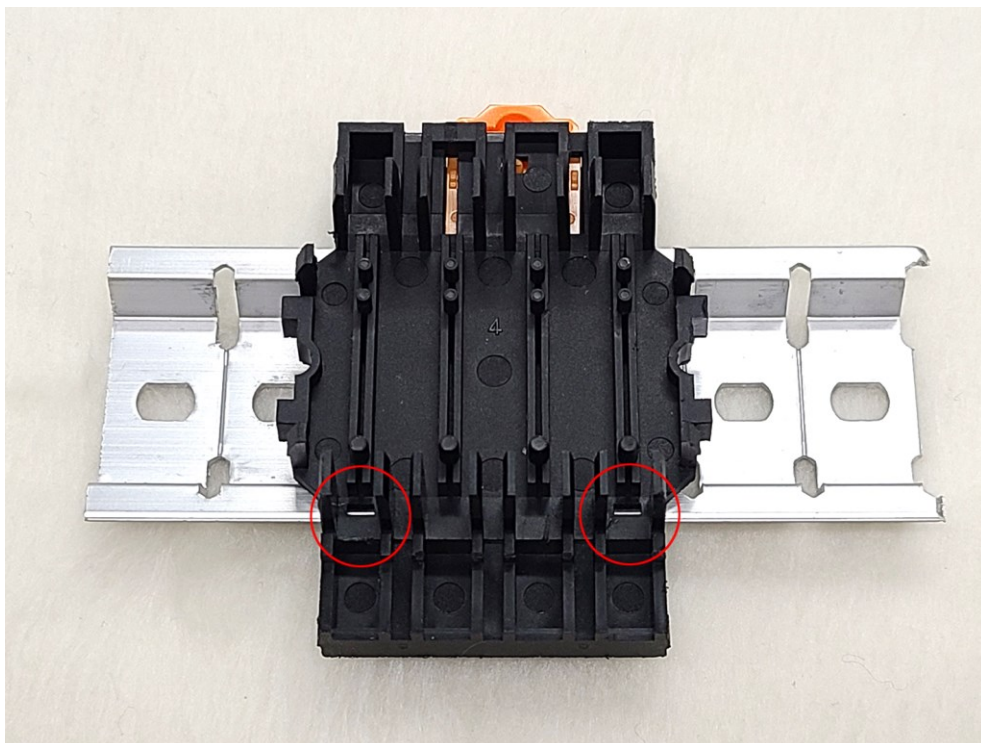

<KH-TDR-R8: Shortest parts of insulation distance analysed by construction review>



<KH-RS-H4CS: Shortest parts of insulation distance analysed by construction review>



## Appendix B Identification number and its layout

 <p>&lt;KH-RS-H4CS&gt;</p>	 <p>Width: 46 mm</p> <p>Logo, Model, Ratings</p> <p>Relay Contact</p> <p>&lt;KH-RS-H4CS&gt;</p>
 <p>Relay Contact</p> <p>Logo, Model, Ratings</p> <p>&lt;KH-RS-H4C&gt;</p>	 <p>Rail: W x H (36 x 68) mm</p> <p>Screw: 2 x M4 x 12 mm</p> <p>&lt;KH-RS-H4C&gt;</p>
 <p>Terminal No. 3, 4, 5, 6</p> <p>Terminal No. 7, 8, 1, 2</p> <p>Model</p> <p>Logo, Model, Ratings</p> <p>&lt;KH-TDR-R8&gt;</p>	 <p>Width: 40 mm</p> <p>Screw: 2xM4x20 mm</p> <p>&lt;KH-TDR-R8&gt;</p>
 <p>&lt;KH-RS-R11&gt;</p>	 <p>Width: 34 mm</p> <p>Screw: 2 x M4 x 30 mm</p> <p>&lt;KH-RS-R11&gt;</p>
 <p>Terminal No. 2, 1, 8, 7</p> <p>Terminal No. 3, 4, 5, 6</p> <p>Logo, Model, Ratings</p> <p>&lt;KH-RS-R8&gt;</p>	 <p>Width: 33 mm</p> <p>Screw: 2xM4x20 mm</p> <p>&lt;KH-RS-R8&gt;</p>

– End of Risk Assessment –

## 2.3 Test Report (LVD)

**TEST REPORT**  
**EN 61984**  
**Connectors – Safety requirements and tests**  
**in conjunction with EN 61810-1:2020**

Report reference No. .... : LR-22-C008

Compiled by (+ signature)..... : S. J., Park    Testing engineer



Reviewed by (+ signature) ..... : Y. H., Jeong    Project reviewer

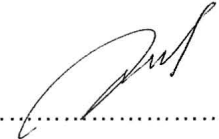

Date of issue..... : September 01, 2022

Total number of pages ..... : 40 pages

Name of Testing Laboratory  
preparing the Report .....

LDNS Co., Ltd.  
Rm.902, 118, LS-ro 116beon-gil, Dongan-gu, Anyang-si,  
Gyeonggi-do, 14118 Republic of Korea

Applicant's name ..... : Kun Hung Electric Co., Ltd.

Address..... : 183, Hancheon-ro, Dongdaemun-gu, Seoul, 02534 Rep. of Korea

**Test specification:**

Standard ..... : EN 61984:2009 in conjunction with EN 61810-1:2020

Test procedure ..... : CE Scheme

Non-standard test method ..... : N/A

Test Report Form No. .... : IEC61984C

Test Report Form(s) Originator .... : VDE Prüf- und Zertifizierungsinstitut GmbH

Master TRF ..... : Dated 2017-06

**Copyright © 2017 IEC System of Conformity Assessment Schemes for Electrotechnical Equipment and Components (IECEE System). All rights reserved.**

This publication may be reproduced in whole or in part for non-commercial purposes as long as the IECEE is acknowledged as copyright owner and source of the material. IECEE takes no responsibility for and will not assume liability for damages resulting from the reader's interpretation of the reproduced material due to its placement and context.

Test item description..... : Relay Socket

Trade Mark..... : 

Manufacturer ..... : Kun Hung Electric Co., Ltd.

Model/Type reference ..... : 1) KH-RS-H4CS    2) KH-RS-H4C    3) KH-TDR-R8  
4) KH-RS-R11    5) KH-RS-R8

Ratings ..... : 10 A, AC 250 V



<b>List of Attachments (including a total number of pages in each attachment):</b>	
Appendix A: Photos (4 pages)	
Appendix B: Mechanical Drawings (5 pages)	
Appendix C: Electrical Drawings (1 page)	
Appendix D: Photos of Test Performance (4 pages)	
Appendix E: List of test equipment used (1 page)	
<b>Summary of testing:</b>	
1) As KH-RS-R8 has almost the same construction with KH-RS-R11 except the number of poles, all the tests of KH-RS-R8 are conducted on KH-RS-R11 model.	
<b>Tests performed (name of test and test clause):</b>	<b>Testing location:</b>
1) Temperature rise (7.3.8)	1) LDNS Co., Ltd. for the other tests
2) Mechanical operation (7.3.9)	Rm.902, 118, LS-ro 116beon-gil, Dongan-gu, Anyang-si, Gyeonggi-do, 14118 Republic of Korea
3) Clearance & creepage distance (7.3.11)	
4) Dielectric strength (7.3.12)	2) Standard LaBs for glow-wire test
5) Corrosion test (7.3.14) – replaced by 14.4 of EN 61810-1:2020	46, LS-ro 91beon-gil, Dongan-gu, Anyang-si, Gyeonggi-do, 14119 Rep. of KOREA
6) Contact retention in insertion (6.18.2)	
7) Contact resistance (IEC 60512 2b)	
8) Ball-pressure test (IEC 60695-10-2)	
9) Flexion test (8.2.4.3 of IEC 60999-1)	
10) Glow-wire test (IEC 60695-2-12)	

Copy of marking plate:



<b>Test item particulars</b> .....	See below.
<b>Classification of installation and use</b> .....	Installed on a standardized DIN rail in an electric cabinet and no direct contact foreseen after installation
<b>Supply Connection</b> .....	10 A, AC 250 V
<b>Enclosure of connector</b> .....	<input checked="" type="checkbox"/> unenclosed connector <input type="checkbox"/> enclosed connector
<b>Fixing style of connector</b> .....	<input checked="" type="checkbox"/> fixed connector <input type="checkbox"/> free connector
<b>Protective Earthing terminal</b> .....	<input type="checkbox"/> with PE terminal <input checked="" type="checkbox"/> without PE terminal
<b>Breaking capacity</b> .....	<input type="checkbox"/> with breaking capacity (CBC) <input type="checkbox"/> IP2X, both of mated and unmated <input type="checkbox"/> IPXXB, both of mated and unmated <input checked="" type="checkbox"/> without breaking capacity (COC) <input checked="" type="checkbox"/> IP0X, unprotected <input type="checkbox"/> IP2X, mated <input type="checkbox"/> IPXXB, mated
<b>Interlock</b> .....	<input type="checkbox"/> with interlock <input checked="" type="checkbox"/> without interlock
<b>Wire connection</b> .....	<input checked="" type="checkbox"/> rewirable connector <input type="checkbox"/> non-rewirable connector
<b>Rated and limiting values for connector:</b>	
- rated insulation voltage $U_i$ (V) .....	AC 250 V
- rated impulse withstand voltage $U_{imp}$ (kV) .....	2.5 kV
<b>Rated frequency (Hz)</b> .....	50/60 Hz
<b>Short-circuit characteristic:</b>	Overcurrent protective device rated as T16AL250V must be installed together with relay contacts in accordance with the leaflet (1.0).
- rated short-circuit current (kA) .....	N/A
- kind of protective device .....	N/A
<b>Pollution degree</b> .....	2
<b>Termination and connection method</b> .....	Screw termination with or without cable lug
<b>Temperature range(LLT-ULT)</b> .....	From -10 °C to +80 °C
<b>Ambient temperature</b> .....	From 0 °C to +40 °C
<b>Connectable conductor</b> .....	Flexible or stranded insulation wire which is connectable within the range of (0.75-1.5) mm <sup>2</sup>

<b>Possible test case verdicts:</b>	
- test case does not apply to the test object..... :	N/A
- test object does meet the requirement .....	P (Pass)
- test object does not meet the requirement..... :	F (Fail)
<b>Testing .....</b> :	
<b>Date of receipt of test item .....</b> :	May 16, 2022
<b>Date (s) of performance of tests .....</b> :	May 19, 2022 – September 01, 2022
<b>General remarks:</b>	
<p>"(See Enclosure #)" refers to additional information appended to the report.          "(See appended table)" refers to a table appended to the report.</p> <p>Throughout this report a <input type="checkbox"/> comma / <input checked="" type="checkbox"/> point is used as the decimal separator.</p>	
<b>Name and address of factory (ies)..:</b>	
Kun Hung Electric Co., Ltd. 183, Hancheon-ro, Dongdaemun-gu, Seoul, 02534 Rep. of Korea	
<b>General product information and other remarks:</b>	
See the leaflet (1.0).	

EN 61984			
Clause	Requirement + Test	Result - Remark	Verdict
	<b>MECHANICAL TEST GROUP A (TABLE 10)</b>		P
A1	VISUAL EXAMINATION: IEC 60512 Test 1a		P
6.2.2	Marking indelible and easily legible	See the marking plate.	P
	Minimum marking on the connector a) trademark		P
	Markings a) trademark and b) type identification on smallest unit of packaging		P
	All other markings (c – k) given in the technical documentation or catalogue of the manufacturer	See below.	P
	c) Rated current .....	10 A; on the marking plate	P
	d) Rated voltage .....	250 V; on the marking plate	P
	e) Over voltage category .....	II, 2 500 V; in the leaflet 1.0	P
	f) Pollution degree .....	2; in the leaflet 1.0	P
	g) Protection degree .....	IP00; in the leaflet 1.0	P
	h) Range of temperature .....	(LLT – ULT), (-10~+80) °C; in the leaflet 1.0	P
	i) Type of terminals .....	Screw terminal; in the leaflet 1.0	P
	j) Connectable conductors .....	Flexible or stranded insulation wire; (0.75–1–1.5) mm <sup>2</sup> or (20–18–16) AWG; in the leaflet 1.0	P
	k) Reference to this standard or to the DS	Shown in the leaflet 1.0	P
6.2.3	Position for the contacts and protective earthing contacts clearly indicated. Marking of protective earthing contacts applies symbol $\oplus$ or “PE”. This requirement is not necessary for non rewirable connectors.	No PE provided	N/A
6.9.2	Fixing means not used to fix live parts.	Installed on a standard DIN rail	P
6.9.3	Termination without damage possible.		P
6.10	CBC has adequate breaking capacity.	COC specified	N/A
6.11	Free connector: Wires protected against shear and tensile stress at the termination and secured to prevent twisting.	Fixed connector	N/A
	The above requirement does not apply to:		N/A
	a) free connectors for termination to cables in fixed mountings (plug connection in the sense of a detachable connection)		N/A
	b) free connectors in which the terminations are protected against pull and twisting by mounting provisions in the end-use product		N/A
	<b>DIMENSIONAL EXAMINATION: IEC 60512</b>		P
6.19	Clearances and creepage distances according to IEC 60664.	see the appended Table 0.2.	P
	Connector dimensions comply with the DS or manufacturer’s specification.	See the dimensional specification of Appendix B.	P

EN 61984			
Clause	Requirement + Test	Result - Remark	Verdict
A2	DURABILITY OF MARKING		N/A
7.3.2	Test liquid: water Test piston size 1; force 5 N; 10 cycles IEC 60068-2-70 Test Xb „Abrasion of marking“	1) No further touching necessary after initial installation 2) Likelihood of accessing the markings is very low.	N/A
	VISUAL EXAMINATION: IEC 60512 Test 1a		P
	Visible with the naked eye		P
A3	POLARISATION AND CODING: IEC 60512 / Test [13e]		P
	- For unenclosed connectors (internal connections) 20 N		P
	- For enclosed connectors (external connections) 1,5 x mating force, but not higher than 80 N		N/A
6.3	Multipole connector: Contact between protective earthing contacts and live contacts is not possible by engagement.	No PE provided	N/A
6.9.1	Multipole connector: Polarisation prevents improper connection of mating parts.		P
	VISUAL EXAMINATION: IEC 60512 Test 1a		P
	No damage likely to impair function		P
A4	PROVISIONS FOR EARTHING		N/A
6.5.1	For a CBC the earthing contact is a “first make - last break” contact.	No PE provided	N/A
7.3.3	No electrical contact indication between earth contact and the other contacts.		N/A
6.5.4	CONNECTION OF THE PROTECTIVE EARTH CONNECTOR		N/A
	VISUAL EXAMINATION: IEC 60512 Test 1a		N/A
	Remove any available covers if required.		N/A
6.5.4.1	The protective conductor terminal accepts a conductor with a minimum cross-section as specified in Table 1, Column 2:		N/A
	Minimum cross- section according to Table 1.....:	mm <sup>2</sup>	—
6.5.4.2	With regard to design and type of construction, the protective conductor terminations are at least equivalent to the other terminations according to clause 6.:		N/A
A5	INTERLOCK		N/A
7.3.4	The specimens are engaged by hand over their full engagement distance. All other contacts are wired in series. The interlock contacts “make last and break first”, before any other contact does.	No interlock function	N/A
6.7	The connector with an interlock cannot be engaged or disengaged as long as the contacts are live.		N/A

EN 61984			
Clause	Requirement + Test	Result - Remark	Verdict
A6	TERMINATIONS		P
6.6	Range of connectable conductor(s) .....	from: 0.75 mm <sup>2</sup> to: 1.5 mm <sup>2</sup>	—
6.6.1 a)	Test acc. to: IEC 60352-1 Wrapped connections		N/A
6.6.1 b)	Test acc. to: IEC 60352-2 Crimped connections		N/A
6.6.1 c)	Test acc. to: IEC 60352-3 or IEC 60998-2-3 Accessible insulation displacement connections		N/A
6.6.1 d)	Test acc. to: IEC 60352-4 or IEC 60998-2-3 Non-accessible insulation displacement connections		N/A
6.6.1 e)	Test acc. to: IEC 60352-5 Press-in connections		N/A
6.6.1 f)	Test acc. to: IEC 60352-6 or IEC 60998-2-3 Insulation piercing connections		N/A
6.6.1 g)	Test acc. to: IEC 60999-1 or IEC 60999-2 or IEC 60352-7 Screwless-type clamping units		N/A
6.6.1 h)	Test acc. to: IEC 60999-1 or IEC 60999-2 Screw-type clamping units	1) See appended table 0.3.5.	P
6.6.1 i)	Test acc. to: IEC 60760 or IEC 61210 Flat, quick-connect terminations	See appended table 0.3.6.	P
	Test acc. to: IEC 60068-2-20 Solder terminations		N/A
	Other terminations, not mentioned above, acc. to IEC standard .....		N/A
A7	CONTACT RETENTION IN INSERT: IEC 60512 Test 15a		P
	Test load shall be three times the specified insertion force (mating) of one contact or the specified insertion force of one contact plus 50 N, whichever is less. Minimum test load 20 N.	1) Connection: (60-90) N 2) Disconnection: (20-60) N	—
	VISUAL EXAMINATION: IEC 60512 Test 1a		P
6.18.2	Contacts safety retained		P
	No axial displacement likely to impair normal operation		P
A8	CABLE CLAMP: IEC 60512		N/A
6.17	The cable clamp is made of insulating material or metal.	No such a construction	N/A
6.17	Metal cable clamps meet one of the following requirements:		N/A
	a) Provided with a covering of insulating material to prevent any accessible metal part becoming live in case of a fault.		N/A
	b) No contact possible with the IEC test finger according to IEC 60529.		N/A
	c) Be connected to protective earth.		N/A

EN 61984			
Clause	Requirement + Test	Result - Remark	Verdict
	Cable clamping range (6.17 Table 6 or manufacturer's specification) .....	from: mm to: mm	—
A8.1	CABLE CLAMP (PULL) IEC 60512 Test 17c		N/A
	VISUAL EXAMINATION: IEC 60512 Test 1a		N/A
	Covers mounted / contacts not connected	See appended table A8.1	N/A
A8.2	CABLE CLAMP (TORSION): IEC 60512 Test 17d		N/A
	VISUAL EXAMINATION: IEC 60512 Test 1a		N/A
	Covers mounted	See appended table A8.2	N/A
A9	MECHANICAL STRENGTH IMPACT (Only free Connectors and CBC): IEC 60512 Test 7b		N/A
	Dropping cycles: 8 positions in 45° steps	COC fixed connector	—
	Dropping height .....	mm	—
	VISUAL EXAMINATION: IEC 60512 Test 1a		N/A
6.18.1	No damage likely to impair safety		N/A
6.18.3	Internal insulations not damaged		N/A
	Parts against electric shock not damaged		N/A
	Clearances and creepage distances not reduced		N/A
	<b>SERVICE LIFE TEST GROUP B (TABLE 11)</b>		P
B1	INITIAL MEASUREMENTS (CONTACT RESISTANCE): IEC 60512 Test 2b		P
	Reference value for subsequent measurement:	See appended Table B1.	—
	Test current .....	10 A	—
B2	BREAKING CAPACITY (ONLY FOR CBCs)		N/A
7.3.5	Operating cycles .....		—
	Speed of insertion/ withdrawal .....	0,8 m/s	—
	Test voltage .....	V	—
	Test current .....	A	—
	Power factor / $\cos(\varphi)$ .....	$0,9 \pm 0,05$	—
	Time constant	$1 \text{ ms} \pm 15\%$	—
	VISUAL EXAMINATION: IEC 60512 Test 1a		N/A
6.14.2	No damage occurred, which could impair normal use		N/A
B3	MECHANICAL OPERATIONS: IEC 60512 Test 9a		P
7.3.9	Operating cycles .....	10; see the photo in the Appendix D.	—
	Insertion speed .....	0,01 m/s	—
	Rest .....	30 s	—
	VISUAL EXAMINATION: IEC 60512 Test 1a		P



EN 61984			
Clause	Requirement + Test	Result - Remark	Verdict
6.14.1	No damage occurred, which could impair normal use		P
B4	FINAL MEASUREMENTS (CONTACT RESISTANCE): IEC 60512 Test 2b		P
	Test current .....	10A	—
	$R2 \leq 1,5 R1$ or $R2 \leq 5 \text{ m}\Omega + R1$ .....	See appended table B4.1.	P
	DIELECTRIC STRENGTH: IEC 60512 Test 4a		P
	a) Impulse withstand voltage .....	kV	—
	b) r.m.s. withstand voltage .....	1.39 kV between DIN rail and terminals	—
6.13	No breakdown or flashover occurred	See appended table B4.2.	P
B5	BENDING (FLEXING) TEST (To be performed on new specimen)		N/A
7.3.10	Only non-rewirable connectors		N/A
	Rated current .....	A	—
	Rated voltage .....	V	—
	Wire cross section .....	mm <sup>2</sup>	—
	Load: $> 0,75 \text{ mm}^2 / 20 \text{ N}$ ; $\leq 0,75 \text{ mm}^2 / 10 \text{ N}$	N	—
	Numbers of bending .....		—
	DURING THE TEST		N/A
	No interruption of the test current		N/A
	No short-circuit between the conductors		N/A
	AFTER THE TEST		N/A
	Cable support sleeve not loosened from the body		N/A
	Insulation shows no signs of abrasion or of wear and tear.		N/A
	Broken strands do not pierce the insulation.		N/A
	VISUAL EXAMINATION: IEC 60512 Test 1a		N/A
6.14.3	No damage occurs, which could impair normal use.		N/A

<b>THERMAL TEST GROUP C (TABLE 12)</b>			
Clause	Requirement + Test	Result - Remark	Verdict
C1	TEMPERATURE RISE TEST: IEC 60512 Test 5A		P
	Test conductor length according Table 7.....	50 cm	—
	Test conductor cross-section .....	1.0 mm <sup>2</sup>	—
7.3.7	Mated specimen .....	4-pole general relay	—
	Test current .....	10 A	—
	Ambient temperature – components .....	(0-40) °C	—
	Upper limit temperature – components .....	+80 °C	—
6.16	The upper limiting temperature specified for the specimen is not exceeded	See appended Table C1.	P

EN 61984			
Clause	Requirement + Test	Result - Remark	Verdict
	<b>CLIMATIC TEST GROUP D (TABLE 13)</b>		P
D1	INITIAL MEASUREMENTS (CONTACT RESISTANCE): IEC 60512 Test 2b		P
	Reference value for subsequent measurement ...:	See appended table D1.	—
	Test current .....	10 A	—
D2	COLD: IEC 60512 Test 11j		P
	Mated specimen .....	General relays; KH-103-H4C, KH-102-3C, KH-102-2C	—
	Test duration .....	2 h	—
	Lower temperature limit .....	-10 °C	—
	VISUAL EXAMINATION: IEC 60512 Test 1a		P
6.6.3	Sufficient contact pressure through insulation		P
6.8 / 6.15	No visual damage, no cracks on insulations parts likely to impair safety		P
6.18.3	Internal insulation shows no damage likely to impair safety		P
	No damage occurred, which could impair normal use	See the photos in the Appendix D.	P
D3	DRY HEAT: IEC 60512 Test 11i		P
	Mated specimen .....	General relays; KH-103-H4C, KH-102-3C, KH-102-2C	—
	Test duration .....	7 days	—
	Upper temperature limit .....	80 °C	—
	VISUAL EXAMINATION: IEC 60512 Test 1a		P
6.6.3	Sufficient contact pressure through insulation		P
6.8 / 6.15	No visual damage, no cracks on insulations parts likely to impair safety		P
6.18.3	Internal insulation shows no damage likely to impair safety		P
	No damage occurred, which could impair normal use	See the photos in the Appendix D.	P
D4	PROTECTION AGAINST CORROSION: IEC 60512 Test 11g		P
7.3.14 Test 1	Flowing mixed gas corrosion according to IEC 60512-11-7, test 11g Method 1 or alternatively Method 4 (Table 1 of IEC 60512-11-7)). Test duration is 4 days.	1) Based on EN 61810-1:2020, this corrosion test replaced by a dry heat steady state test in accordance with IEC 60068-2-2, Test Bb at 80 °C for 240 h 2) See the photos in the Appendix D.	P
7.3.14 Test 2 alternative	Sulphur dioxide test with general condensation of moisture according to ISO 6988. Test duration is 24h (1 test cycle)	See above.	N/A
	VISUAL EXAMINATION: IEC 60512 Test 1a		P

EN 61984			
Clause	Requirement + Test	Result - Remark	Verdict
6.21	Function guaranteed		P
	No damage occurred, which could impair normal use	See the photos in the Appendix D.	P
D5	FINAL MEASUREMENT (CONTACT RESISTANCE): IEC 60512 Test 2b		P
	Test current .....	10 A	—
	$R2 \leq 1,5 R1$ or $R2 \leq 5 \text{ m}\Omega + R1$ .....	See appended table D5.	P
D6	DIELECTRIC STRENGTH: IEC 60512 Test 4a		P
	Mated specimen .....		—
	Impulse withstand voltage .....		—
	r.m.s. withstand voltage .....	1.39 kV	—
6.13	No breakdown or flashover occurred	See appended table D6.	P

	<b>DEGREE OF PROTECTION TEST GROUP E (TABLE 14)</b>		P
E1	PROTECTION AGAINST ELECTRIC SHOCK		P
	Unenclosed connectors (for use inside an enclosure):		P
	5.4 c1) COC classified as IP0X, no test required		P
6.4.2.2	5.4 c2) COC Hand back safety (IP1X or IPXXA) 50 mm sphere pressed with 20 N against mated specimen. No live parts accessible.		N/A
6.4.2.3	5.4 c3) COC Finger safety (IP2X or IPXXB) Jointed test finger pressed with 20 N against mated specimen. No live parts accessible.		N/A
6.4.2.3	5.4 d) CBC finger safety (IP2X or IPXXB) Jointed test finger pressed with 20 N against mated and unmated specimen. No live parts accessible.		N/A
	Enclosed connectors (COCs and CBCs)		N/A
6.4.1	Test at mated and unmated specimen. Jointed IEC test finger pressed with 20 N against the surface except the mating face of the male part of the connector. Creepage and clearances ensured between live parts and test finger.		N/A
	All parts necessary to ensure protection against electric shock only removable with a tool.		N/A
6.4.3	For a CBC, protection against electric shock is ensured also during insertion and withdrawal. This is proved by use of the jointed IEC test with a test force of 20 N. Creepage and clearances ensured between live parts and test finger.		N/A

EN 61984			
Clause	Requirement + Test	Result - Remark	Verdict
E2	PROVISION FOR EARTHING		N/A
7.3.13 6.5.3	Resistance between accessible metal parts and the earthing contact $\leq 100 \text{ m}\Omega$ ..... :	m $\Omega$	N/A
E3	DEGREE OF PROTECTION IP CODE: IEC 60529		N/A
7.3.6.3	Tests for IP Codes higher than IP2X or IPXXB		N/A
6.12 7.3.7.1	IP code according to IEC 60529 in mated condition or according manufacturers conditions .....	IP00	—
	Maximum and minimum cross-section wiring or cable diameter connected .....	mm <sup>2</sup> / $\varnothing$ mm mm <sup>2</sup> / $\varnothing$ mm	—
7.3.7.2	Protection against ingress of foreign solid objects, tested according to IEC 60529		N/A
7.3.7.3	Protection against harmful ingress of water, tested according to IEC 60529		N/A

A8.1	<b>TABLE: Covers mounted / contacts not connected</b>				N/A
Nominal size (mm):	∅ [mm]	Tensile force [N]		Displacement [mm]	—
	Min.			≤	
	Max.				

A8.2	<b>TABLE: Covers mounted</b>				N/A
Nominal size (mm):	∅ [mm]	Torque [Nm]		Twist [ ° ]	—
	Min.			≤ ±	
	Max.				

B1	<b>TABLE: Initial measurements (Contact resistance)</b>					P
Test current .....				10 A		—
Test sample	Contact	1	2	3	PE	—
KH-RS-H4CS	ΔU1 [mV]	131	145	129	N/A	P
	R1 [mΩ]	13.1	14.5	12.9	N/A	
	Contact	1	2	3	PE	—
KH-RS-H4C	ΔU1 [mV]	180	175	171	N/A	P
	R1 [mΩ]	18.0	17.5	17.1	N/A	
	Contact	1	2	3	PE	—
KH-TDR-R8	ΔU1 [mV]	127	150	—	N/A	P
	R1 [mΩ]	12.7	15.0	—	N/A	
	Contact	1	2	3	PE	—
KH-RS-R11	ΔU1 [mV]	146	159	115	N/A	P
	R1 [mΩ]	14.6	15.9	11.5	N/A	
supplementary information:						

B4.1		TABLE: Final measurements (Contact resistance)					
Test current..... :		10 A					—
Number of cycles..... :		10					—
Condition..... :		$R_{2max} \leq 1,5R_1$ or $R_{2max} \leq 5 \text{ m}\Omega + R_1$					—
Test sample	Contact	1	2	3	PE	—	
KH-RS-H4CS	1.5R1	19.65	21.75	19.35	N/A	P	
	R2max [mΩ]	12.0	12.0	12.0	N/A		
	ΔU2 [mV]	107	120	113	N/A		
	R2 [mΩ]	10.7	12.0	11.3	N/A		
	Contact	1	2	3	PE	—	
KH-RS-H4C	1.5R1	27.00	26.25	25.65	N/A	P	
	R2max [mΩ]	18.3	18.3	18.3	N/A		
	ΔU2 [mV]	183	140	156	N/A		
	R2 [mΩ]	18.3	14.0	15.6	N/A		
	Contact	1	2	3	PE	—	
KH-TDR-R8	1.5R1	19.05	22.50	—	N/A	P	
	R2max [mΩ]	13.5	13.5	—	N/A		
	ΔU2 [mV]	135	115	—	N/A		
	R2 [mΩ]	13.5	11.5	—	N/A		
	Contact	1	2	3	PE	—	
KH-RS-R11	1.5R1	21.90	23.85	17.25	N/A	P	
	R2max [mΩ]	14.2	14.2	14.2	N/A		
	ΔU2 [mV]	127	114	142	N/A		
	R2 [mΩ]	12.7	11.4	14.2	N/A		
supplementary information:							

B4.2		TABLE: Dielectric strength (mated specimen)			P
Test voltage applied between:		a) Impulse withstand voltage applied	b) r.m.s withstand voltage applied	Breakdown / flashover (Yes/No)	
Live – Live		—	1.39 kV	No	
Live – DIN rail		—	1.39 kV	No	
supplementary information:					

C1		TABLE: Temperature rise test				P
Model	Thermocouple Locations	Test current (A)	Upper temperature limit (ULT) (°C)	Temperature measured (°C)	—	
KH-RS-H4CS	Front Terminal (2)	10	80	65.6 (25.6+40)	P	
	Front Terminal (3)	10	80	64.2 (24.2+40)	P	
	Rear Terminal (2)	10	80	73.3 (33.3+40)	P	
	Rear Terminal (3)	10	80	70.9 (30.9+40)	P	
	Body	10	80	61.7 (21.7+40)	P	
	Ambient	—	—	22.8	—	
KH-RS-H4C	Front Terminal (2)	10	80	79.5 (39.5+40)	P	

C1	TABLE: Temperature rise test				P
Model	Thermocouple Locations	Test current (A)	Upper temperature limit (ULT) (°C)	Temperature measured (°C)	—
	Front Terminal (3)	10	80	79.2 (39.2+40)	P
	Rear Terminal (2)	10	80	78.2 (38.2+40)	P
	Rear Terminal (3)	10	80	76.2 (36.2+40)	P
	Body	10	80	74.3 (34.3+40)	P
	Ambient	—	—	23.1	—
KH-TDR-R8	Front Terminal (2)	10	80	67.3 (27.3+40)	P
	Front Terminal (3)	10	80	66.7 (26.7+40)	P
	Rear Terminal (2)	10	80	66.6 (26.6+40)	P
	Rear Terminal (3)	10	80	63.7 (23.7+40)	P
	Body	10	80	49.6 (9.6+40)	P
	Ambient	—	—	23.1	—
KH-RS-R11	Front Terminal (5)	10	80	70.8 (30.8+40)	P
	Front Terminal (7)	10	80	74.3 (34.3+40)	P
	Rear Terminal (1)	10	80	71.5 (31.5+40)	P
	Rear Terminal (3)	10	80	77.4 (37.4+40)	P
	Body	10	80	63.2 (23.2+40)	P
	Ambient	—	—	23.1	—

supplementary information:

D1	TABLE: Initial measurements (Contact resistance)					P
Test current .....		10 A			—	
Test sample	Contact	1	2	3	PE	—
KH-RS-H4CS	$\Delta U1$ [mV]	101	110	110	N/A	P
	R1 [m $\Omega$ ]	10.1	11.0	11.0	N/A	
KH-RS-H4C	Contact	1	2	3	PE	—
	$\Delta U1$ [mV]	111	110	112	N/A	P
	R1 [m $\Omega$ ]	11.1	11.0	11.2	N/A	
KH-TDR-R8	Contact	1	2	3	PE	—
	$\Delta U1$ [mV]	141	135	—	N/A	P
	R1 [m $\Omega$ ]	14.1	13.5	—	N/A	
KH-RS-R11	Contact	1	2	3	PE	—
	$\Delta U1$ [mV]	132	121	142	N/A	P
	R1 [m $\Omega$ ]	13.2	12.1	14.2	N/A	

supplementary information:

D5		TABLE: Final measurements (Contact resistance)				P
Test current .....		10 A				—
Condition .....		$R_{2max} \leq 1,5R_1$ or $R_{2max} \leq 5 \text{ m}\Omega + R_1$				—
Test sample	Contact	1	2	3	PE	—
KH-RS-H4CS	1.5R1	15.15	16.50	16.50	N/A	P
	R2max [mΩ]	10.5	10.5	10.5	N/A	
	ΔU2 [mV]	95	81	105	N/A	
	R2 [mΩ]	9.5	8.1	10.5	N/A	
	Contact	1	2	3	PE	—
KH-RS-H4C	1.5R1	16.65	16.50	16.80	N/A	P
	R2max [mΩ]	14.8	14.8	14.8	N/A	
	ΔU2 [mV]	126	148	121	N/A	
	R2 [mΩ]	12.4	14.8	12.0	N/A	
	Contact	1	2	3	PE	—
KH-TDR-R8	1.5R1	21.15	20.25	—	N/A	P
	R2max [mΩ]	14.3	14.3	—	N/A	
	ΔU2 [mV]	144	121	—	N/A	
	R2 [mΩ]	14.3	12.1	—	N/A	
	Contact	1	2	3	PE	—
KH-RS-R11	1.5R1	19.80	18.15	21.30	N/A	P
	R2max [mΩ]	16.7	16.7	16.7	N/A	
	ΔU2 [mV]	168	132	161	N/A	
	R2 [mΩ]	16.7	13.2	6.1	N/A	
supplementary information:						

D6		TABLE: Dielectric strength (mated specimen)			P
Test voltage applied between:		a) Impulse withstand voltage applied	b) r.m.s withstand voltage applied	Breakdown / flashover (Yes/No)	
Live – Live		—	1.39 kV	No	
Live – DIN rail		—	1.39 kV	No	
supplementary information:					

0.1		TABLE: Characteristic features	
Example .....	X	Please mark relevant line with "X"	
Kind of equipment	X	Connector without breaking capacity (COC)	
		Connector with breaking capacity (CBC)	
Existence of an enclosure	X	Unenclosed connector	
		Enclosed connector	
Design of the connector	X	Fixed connector	
		Free connector	



0.1	<b>TABLE: Characteristic features</b>	
Example .....	X	Please mark relevant line with "X"
Additional characteristics		Connector with protective earthing contact
	X	Connector without protective earthing contact
		Connector with cable clamp
	X	Connector without cable clamp
	X	Connectors (COC) with protection against electric shock for hand back safety, when mated
		Connectors (COC) with protection against electric shock for finger safety
		CBC with protection against electric shock for finger safety, both in mated and unmated condition
		Degree of protection of a connector
	X	Connector for class II equipment
		Connector with interlock
	X	Connector without interlock
		Non-rewirable connector
	X	Rewirable connector
Pollution degree		1
	X	2
		3
		4
Over voltage category		I
	X	II
		III
		IV
Operating cycles	X	10
		50
		100
		500
		1000
		2000
		5000
		According manufacturer's:

0.1	<b>TABLE: Characteristic features</b>	
Example .....	X	Please mark relevant line with "X"
Bendings		10
		50
		100
		500
		1000
		2000
		5000
		20000
		According manufacturer's:
Upper temperature limit		70°C
		85°C
		100°C
		125°C
	X	According manufacturer's: +80 °C
Lower temperature limit	X	-10°C
		-25°C
		-40°C
		-55°C
		0°C
		According manufacturer's:
Type of conductor		Solid
	X	Flexible, streded
Termination and connection		Wrapped connection
		Crimped connection
		IDC Accessible
		IDC Non-accessible
		Press in connections
		Insulation piercing connections
		Solder termination
		Screwless-type clamping units
	X	Screw-type clamping units
	X	Flat, quick-connect terminations
		According manufacturer's:

0.1		<b>TABLE: Characteristic features</b>	
Example .....	X	Please mark relevant line with "X"	
Values for cable clamp		[4–9 mm]	
		[9-12 mm]	
		[12-20 mm]	
		[20-32 mm]	
		[33-42 mm]	
		[≥ 42 mm]	
	X	According manufacturer's: Not applicable	
Rated voltage(s) .....		250 V	
Rated current .....		10 A	
Rated impulse voltage(s) .....		2 500 V	
Rated insulation voltage(s) .....		250 V	
Number of poles .....		4	
Protection degree (IP-Code) .....		IP00	
Mounting .....		Standard DIN rail installation	
Wire cross section area or cross section range .....		(0.75–1–1.5) mm <sup>2</sup> or (20–18–16) AWG	
Material and coating of female contact :		CuSn	
Material and coating of male contact ... :		N/A	

0.2		<b>TABLE: Clearance and creepage distance measurements</b>			
Type / Shell-size / etc. .... :	Relay socket with screw terminal				
Rated voltage [V] .....	250 V				
Pollution degree .....	2				
Isolation material group .....	IIIb				
Impulse withstand voltage [kV] :	2.5 kV for basic insulation				
Test voltage [kV] .....	1.39 kV for basic insulation				
Clearances required .....	1.5 mm for Basic Insulation, 3.0 mm for Reinforced Insulation				
Clearances measured .....	between the conductive DIN rail and the inner metal part				
	1.KH-RS-H4CS	2.KH-RS-H4C	3.KH-TDR-R8	4.KH-RS-R11	
	5.67 mm	6.78	5.10	> 7.00	
Creepage distances required .. :	2.5 mm for Basic Insulation, 5.0 mm for Reinforced Insulation				
Creepage distances measured :	between the conductive DIN rail and the inner metal part				
	1.KH-RS-H4CS	2.KH-RS-H4C	3.KH-TDR-R8	4.KH-RS-R11	
	5.67 mm	6.78	5.10	> 7.00	
Supplementary information:					

0.3.1 <b>TABLE: IEC 60112 / Tracking test</b>							
Specimen				Erosion depth [mm]			
Part	Material	Material-thickness [mm]	Colour	PTI Test solution [A]	CTI	PTI Test solution [B]	Result
Supplementary information:							

0.3.2 <b>TABLE: IEC 60695-2-11 / Glow-wire-test [60 s]</b>									
Specimen				Flame					
Part	Material	Material-thickness [mm]	Colour	[°C]	Start [s]	End [s]	Height [mm]	Ignition of tissue paper	Result
Relay Body	PA6	Min. 0.8	Black	750	-	-	-	No	Pass
Supplementary information:									

0.3.3 <b>TABLE: IEC 89/336/CD / Ball-pressure test</b>							
Specimen				Ball-pressure test			
Part	Material	Material-thickness [mm]	Colour	[C°]	Measured [mm]	Required [mm]	Result
Socket Housing	PA6, Min. thk.0.8 mm, V-2	1.36	Black	125	0.82	≤ 2.0	P
Supplementary information:							

0.3.4 <b>TABLE: IEC 60695-2-2 / Needle-flame test</b>							
Specimen				Flame			
Part	Material	Material-thickness [mm]	Colour	Burning duration [s]	Start [s]	End [s]	Result
Supplementary information:							

0.3.5 <b>TABLE: IEC 60999-1 / Mechanical strength of terminals</b>			
Clause	Requirement + Test	Result - Remark	Verdict

8.2.4.2	Mechanical strength of terminals		P
	maximum cross-sectional area of conductor (mm <sup>2</sup> )	1.5 mm <sup>2</sup>	P
	diameter of thread (mm)	2.94 mm	P
	torque (Nm)	Not defined for column II	P
	5 times on 2 separate clamping units		P
8.2.4.3	Testing for damage to and accidental loosening of conductor (flexion test)		P

0.3.5 <b>TABLE: IEC 60999-1 / Mechanical strength of terminals</b>			
Clause	Requirement + Test	Result - Remark	Verdict
	conductor of the smallest cross-sectional area (mm <sup>2</sup> ) .....	0.5 mm <sup>2</sup>	P
	number of conductor of the smallest cross section .....	1	P
	diameter of bushing hole (mm) .....	6.5 mm	P
	height between the equipment and the platen (mm) .....	260 mm	P
	mass at the conductor(s) (kg) .....	0.3 kg; actually 0.5 kg used for test; see the test photos at Appendix D.	P
	135 continuous revolutions: the conductor shall neither slip out of the terminal nor break near the clamping unit	Revolutions for 14 minutes at 10 rpm	P
8.2.4.4	Pull-out test		P
	force (N) .....	20 N	P
	1 min, the conductor shall neither slip out of the terminal nor break near the clamping unit	See the test photos at Appendix D.	P
8.2.4.3	Flexion test		P
	conductor of the largest cross-sectional area (mm <sup>2</sup> ) .....	1.5 mm <sup>2</sup>	P
	number of conductor of the largest cross-section ..	1	P
	diameter of bushing hole (mm) .....	6.5 mm	P
	height between the equipment and the platen (mm) .....	260 mm	P
	mass at the conductor(s) (kg) .....	0.4 kg; actually 0.5 kg used for test; see the test photos at Appendix D.	P
	135 continuous revolutions: the conductor shall neither slip out of the terminal nor break near the clamping unit		P
8.2.4.4	Pull-out test		P
	force (N) .....	35 N	P
	1 min, the conductor shall neither slip out of the terminal nor break near the clamping unit	See the test photos at Appendix D.	P

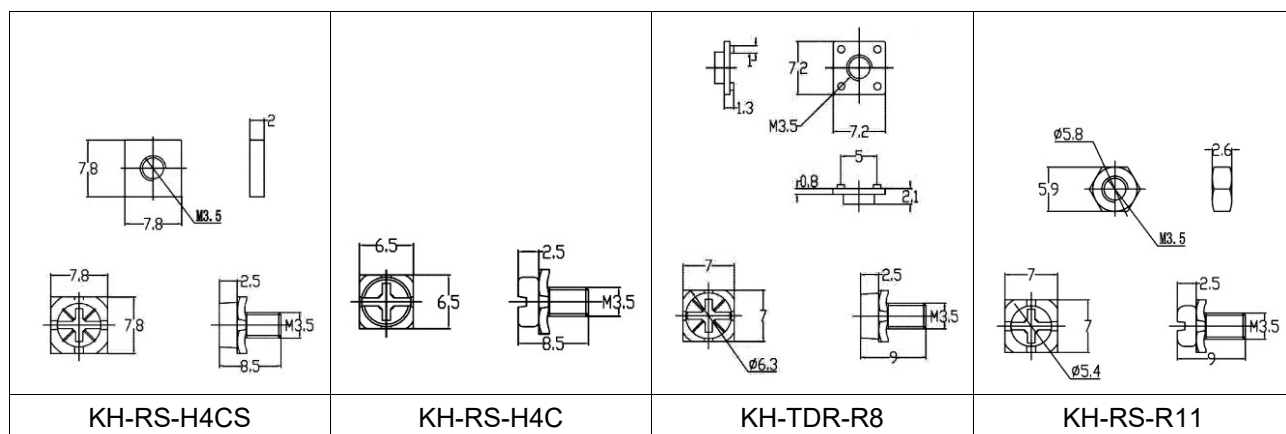

<Nominal dimension for each screw and square washer>

IEC 61210		A	B min.	C	D	E	F	J	M	N	# min.	## min.	P	Q min.	TABLE: 0.3.6 [NOMINAL SIZE]	
		[mm]	[mm]	[mm]	[mm]	[mm]	[mm]	[°]	[mm]	[mm]	[mm]	[mm]	[mm]	[mm]		
2,8x0,5	Dimple detent	0,6	7,0	0,54	2,9	1,8	1,3	12	1,7	1,4	0,076	○ 0,076	1,4	8,1		
	Hole	0,3		0,47	2,7	1,3	1,1	8	1,4	1,0		□ 0,13	0,3	8,1		
2,8x0,8	Dimple detent	0,6	7,0	0,54	2,9	1,8	1,3	12	1,7	1,4	0,076	○ 0,076	1,4	8,1		
	Hole	0,3		0,47	2,7	1,3	1,1	8	1,4	1,0		□ 0,13	0,3	8,1		
4,8x0,5	Dimple detent	0,9	6,2	0,54	4,8	2,8	1,5	12	1,7	1,5	0,076	○ 0,076	1,7	7,3		
	Hole	0,6		0,47	4,6	2,3	1,3	8	1,4	1,2		□ 0,13	0,6	7,3		
4,8x0,8	Dimple detent	1,0	6,2	0,84	4,8	2,8	1,5	12	1,7	1,5	0,076	○ 0,076	1,8	7,3		
	Hole	0,7		0,77	4,6	2,3	1,3	8	1,4	1,2		□ 0,13	0,7	7,3		
6,3x0,8	Dimple detent	1,0	7,8	0,84	6,4	4,1	2,0	12	2,5	2,0	0,076	○ 0,076	1,8	8,9		
	Hole	0,7		0,77	6,2	3,6	1,6	8	2,2	1,8		□ 0,13	0,7	8,9		
9,5x1,2	Hole	1,3	12,0	1,23	9,6	5,5	2,0	14				0,076	2,0	13,1		
		0,7		1,17	9,4	4,5	1,7	6					1,0			
		Measured values														
2,8x0,5	<input type="checkbox"/> Hole															Dimple detent <input type="checkbox"/> Round <input type="checkbox"/> Rectangular
2,8x0,8	<input type="checkbox"/> Hole															Dimple detent <input type="checkbox"/> Round <input type="checkbox"/> Rectangular
4,8x0,5	<input checked="" type="checkbox"/> Hole	-	-	-	-	-	2.60	-	-	-	0.06	-	-	-		Dimple detent <input type="checkbox"/> Round <input type="checkbox"/> Rectangular
4,8x0,8	<input type="checkbox"/> Hole															Dimple detent <input type="checkbox"/> Round <input type="checkbox"/> Rectangular
6,3x0,8	<input type="checkbox"/> Hole															Dimple detent <input type="checkbox"/> Round <input type="checkbox"/> Rectangular
9,5x1,2	<input type="checkbox"/> Hole															Dimple detent <input type="checkbox"/> Round <input type="checkbox"/> Rectangular

Note: General relay of KH-103-H4C provided for test

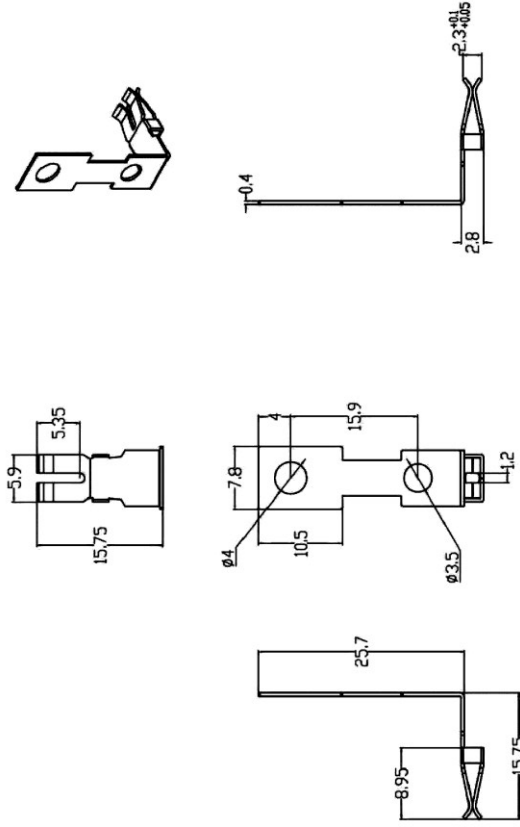

KH-RS-H4CS

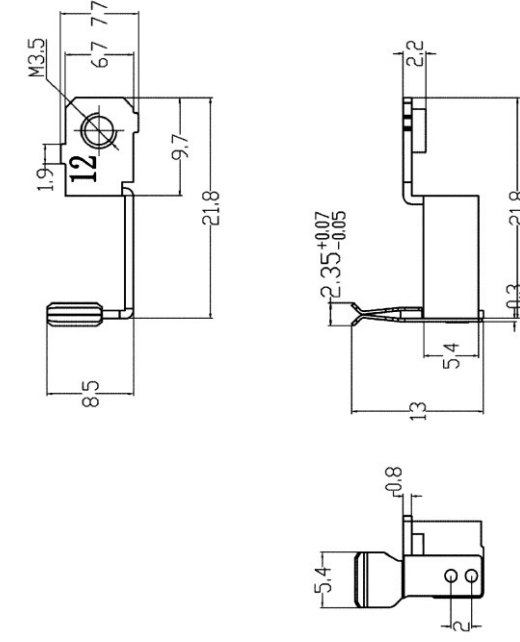

KH-RS-H4C

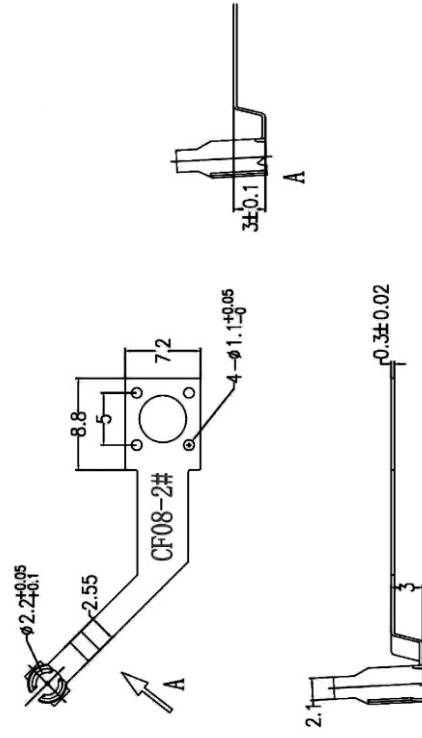

KH-TDR-R11

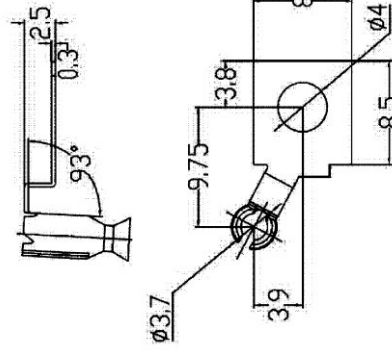

KH-RS-R11

<Receptacle for each relay tap>

CCL	<b>TABLE: List of Critical Components</b>				
Object/part No.	Manufacturer / trademark	Type/model	Technical data	Standard (Edition / year)	Mark(s) of conformity
Relay Base	CGN Juner New Materials Co.,Ltd.	PA-A6-2	PA6, Min. thk.0.8 mm, V-2	IEC 60695-11-10	UL (E204321)
			GWFI: Min. thk. 1.5mm, 750 °C	IEC 60695-2-12	Tested in EUT; see TABLE 0.3.2
			Ball-pressure at 125 °C	IEC 60695-10-2	Tested in EUT; see TABLE 0.3.3
Supplementary information:					



### Appendix A: Photos

#### 1) KH-RS-H4CS

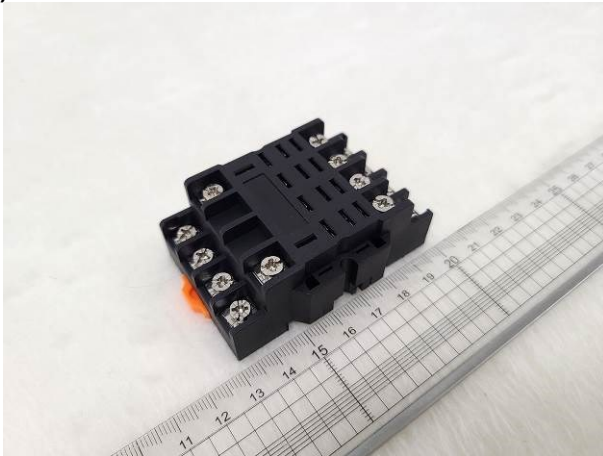

<Top view>



<Bottom view>

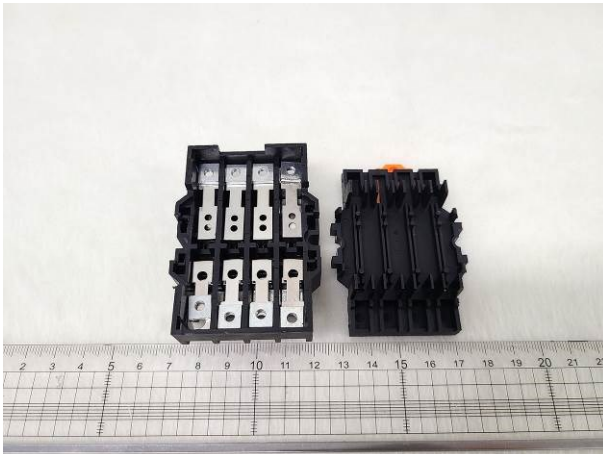

<Inner view>

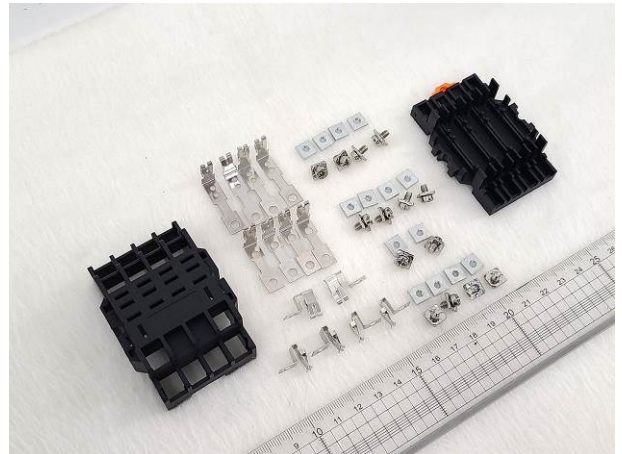

<Exploded view>

#### 2) KH-RS-H4C



<Top view>

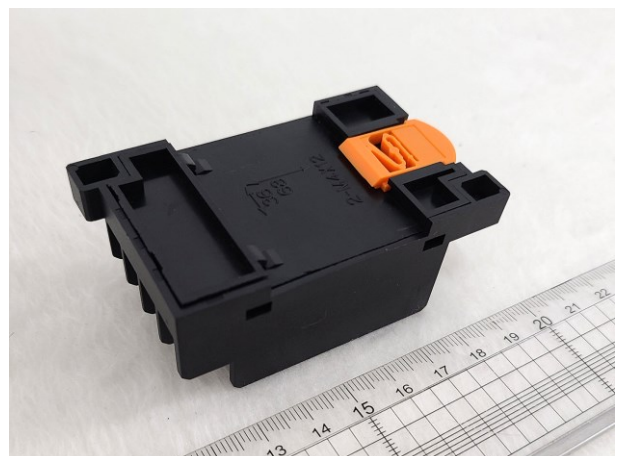

<Bottom view>

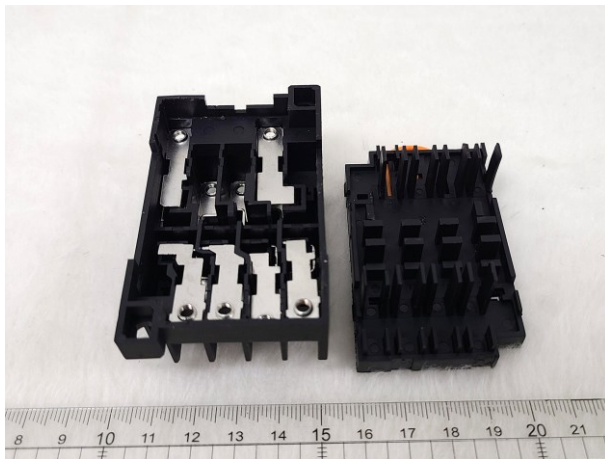

<Inner view>

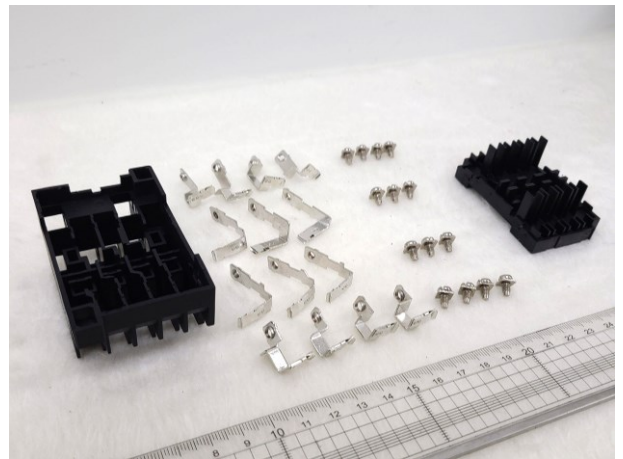

<Exploded view>

**3) KH-TDR-R8**



<Top view>



<Bottom view>

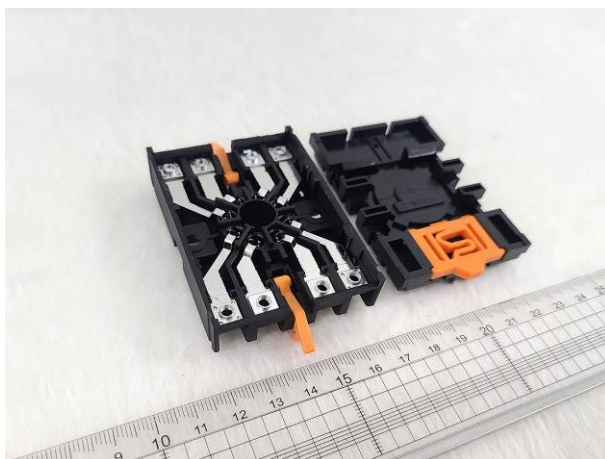

<Inner view>

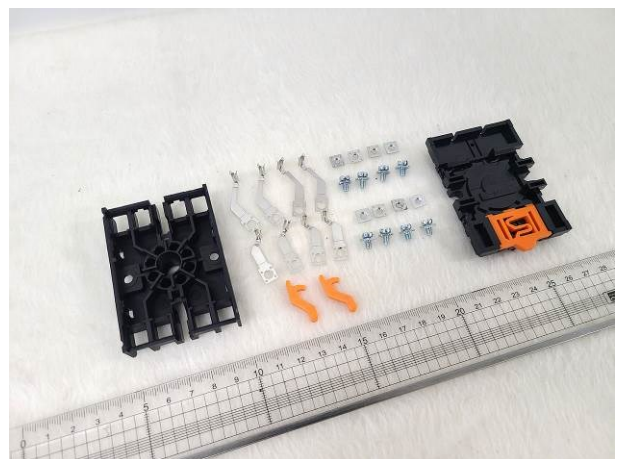

<Exploded view>



4) KH-RS-R11

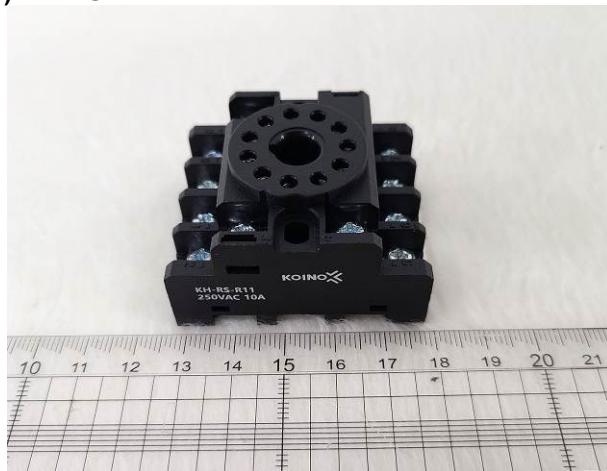

<Top view>

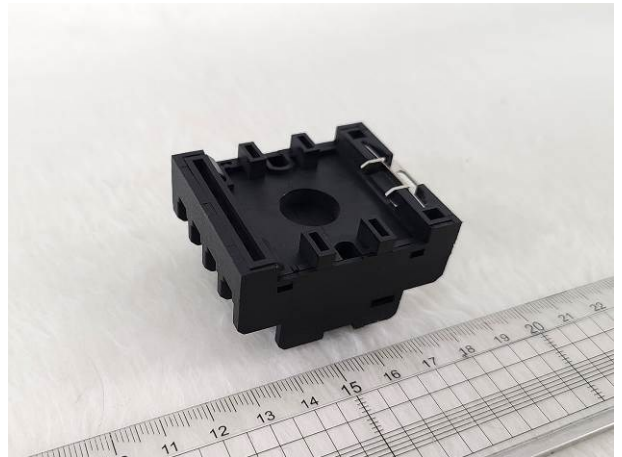

<Bottom view>

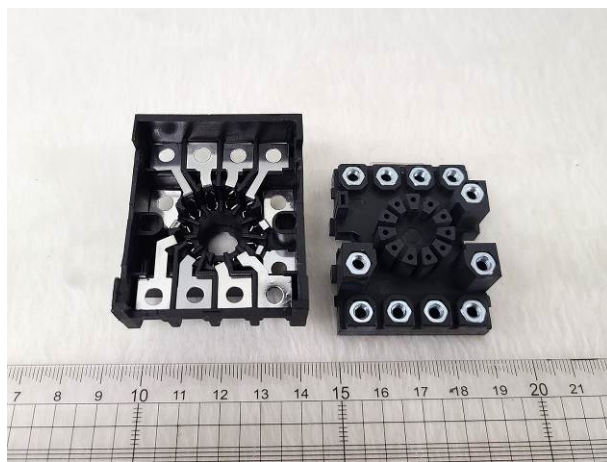

<Inner view>

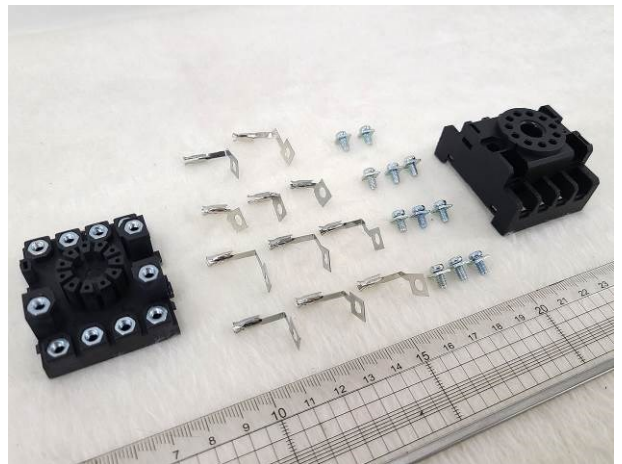

<Exploded view>

4) KH-RS-R8



<Top view>



<Bottom view>

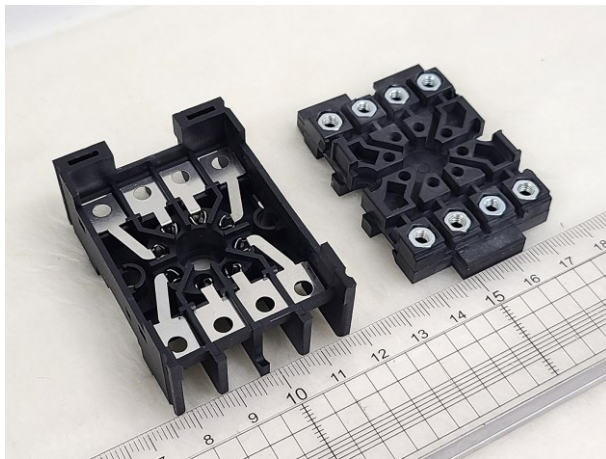

<Inner view>

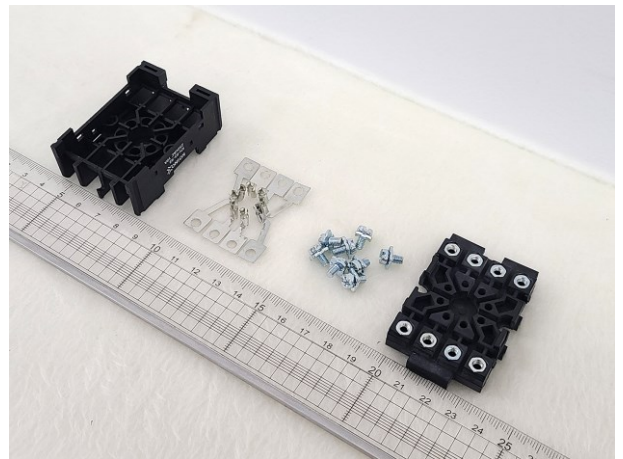

<Exploded view>

### Appendix B: Mechanical Drawings

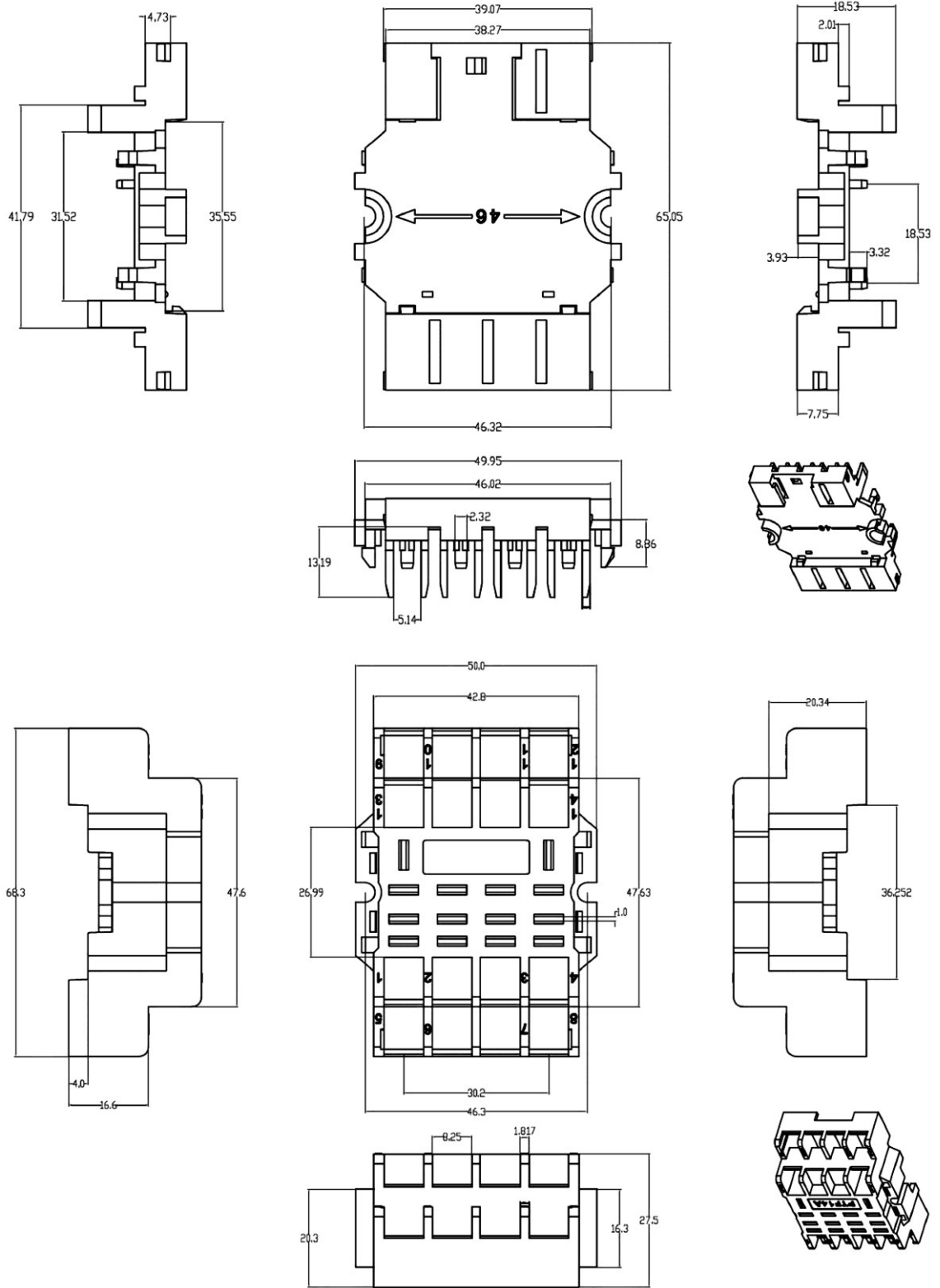

<KH-RS-H4CS>

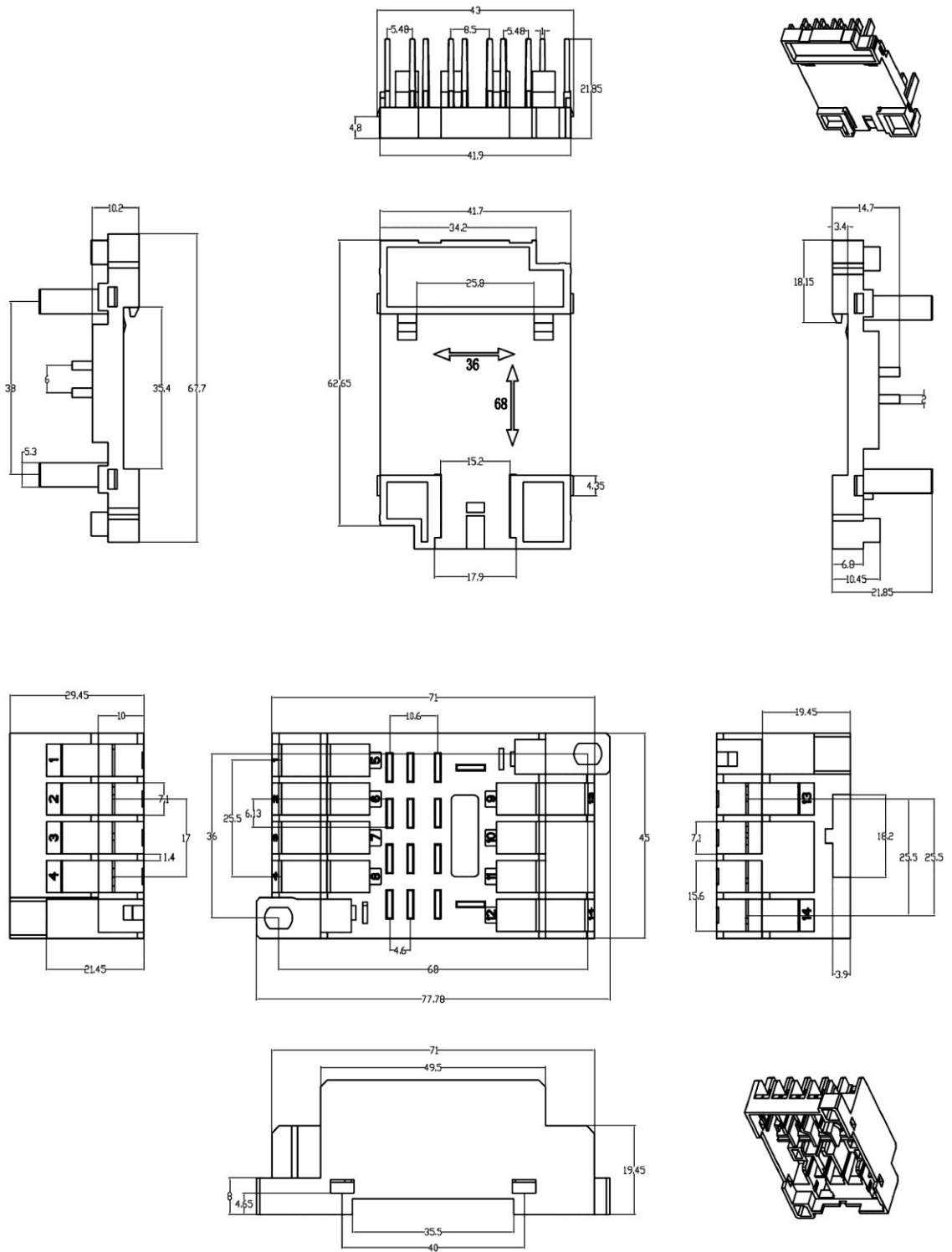

<KH-RS-H4C>

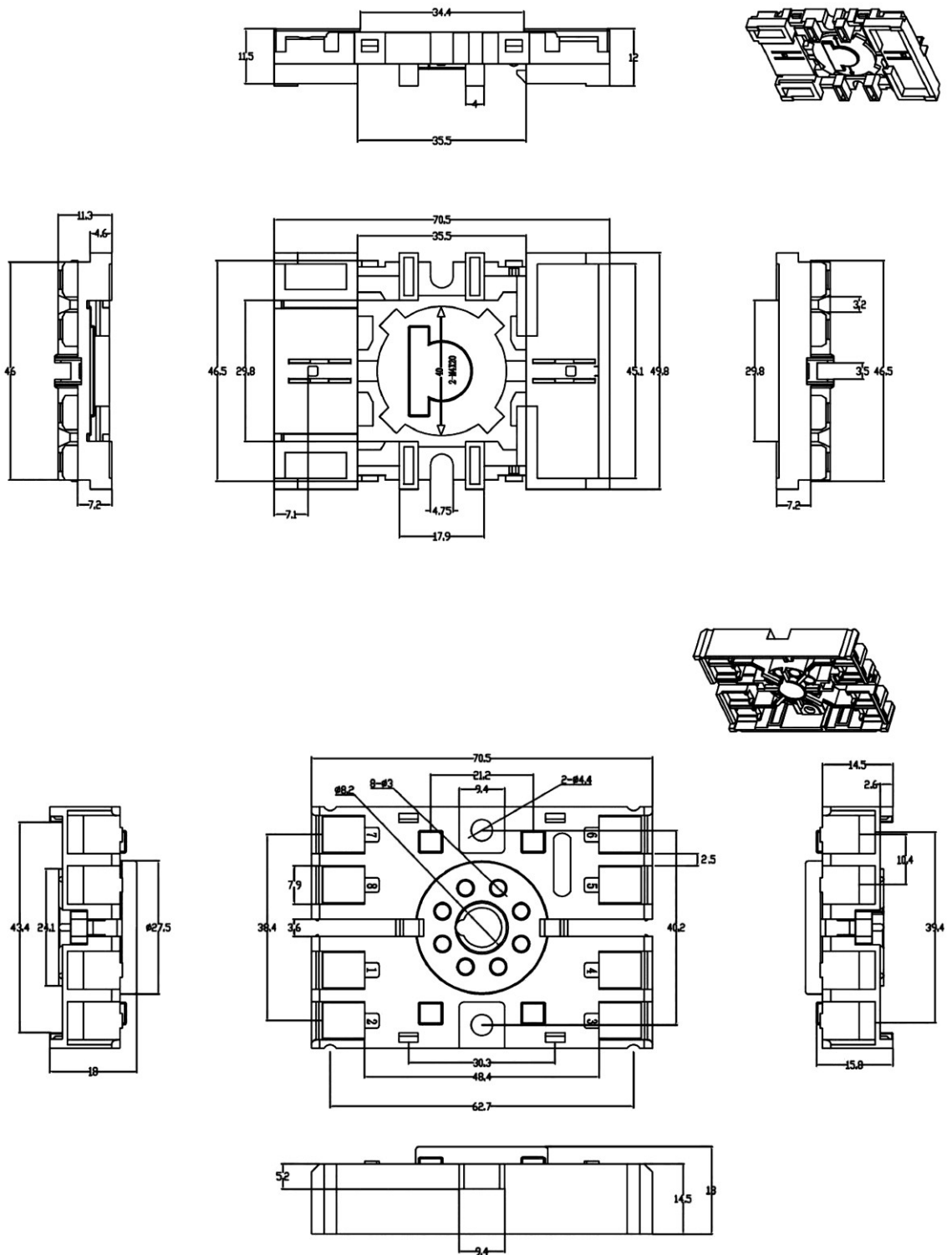

<KH-TDR-R8>

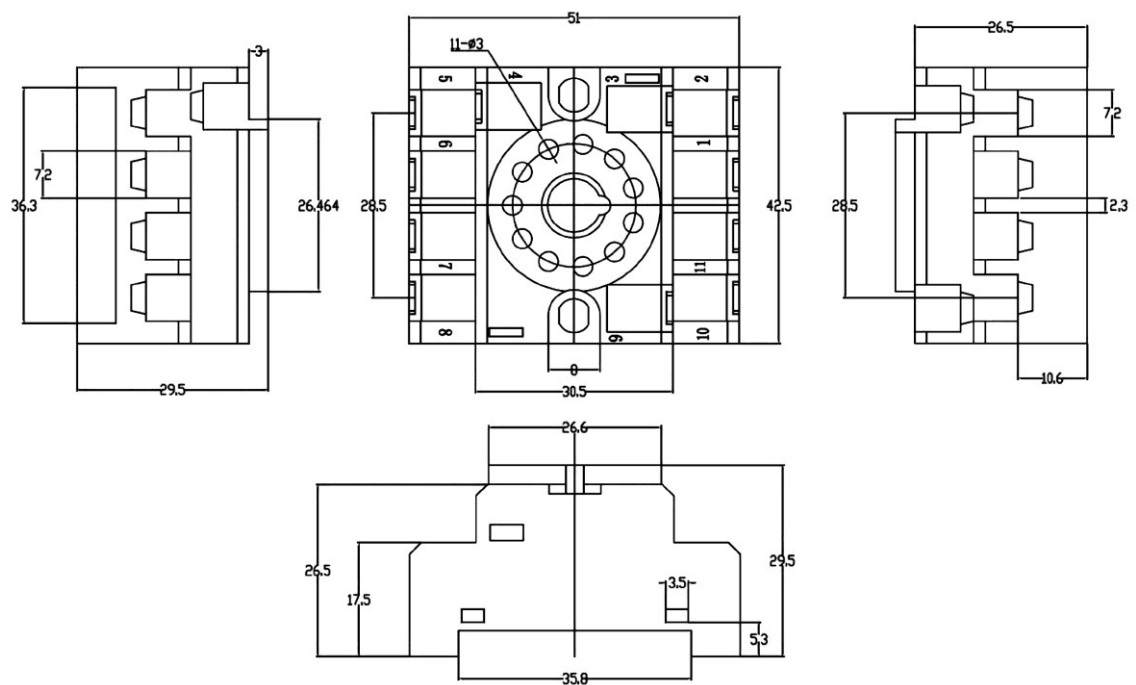
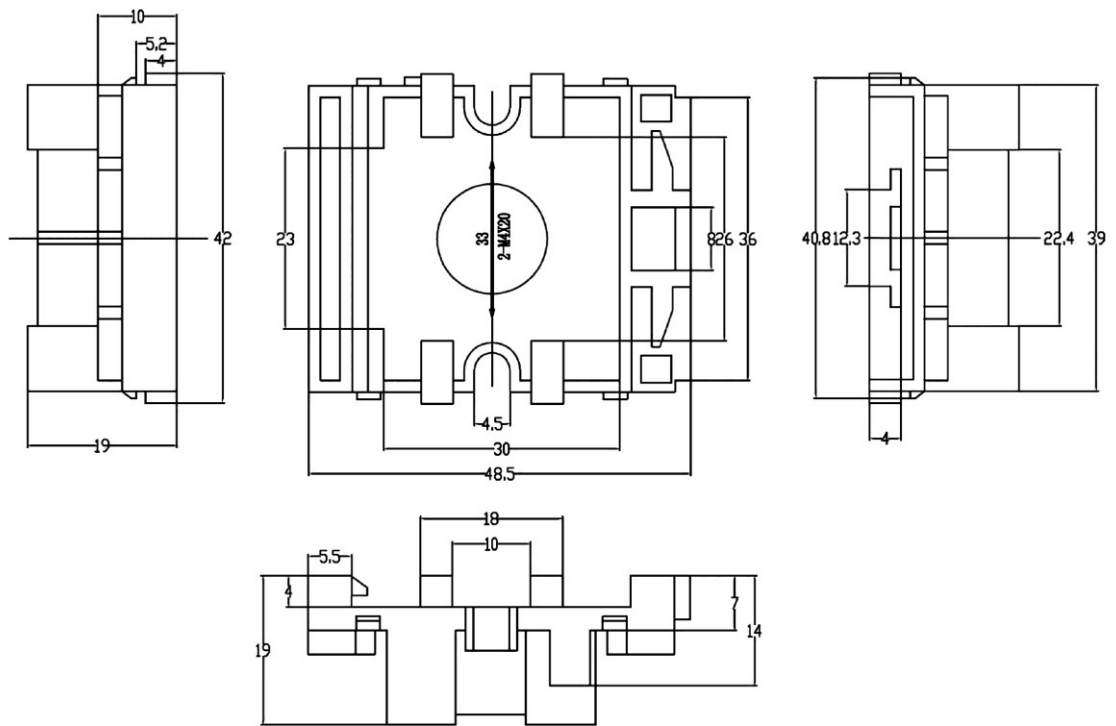

<KH-RS-R11>



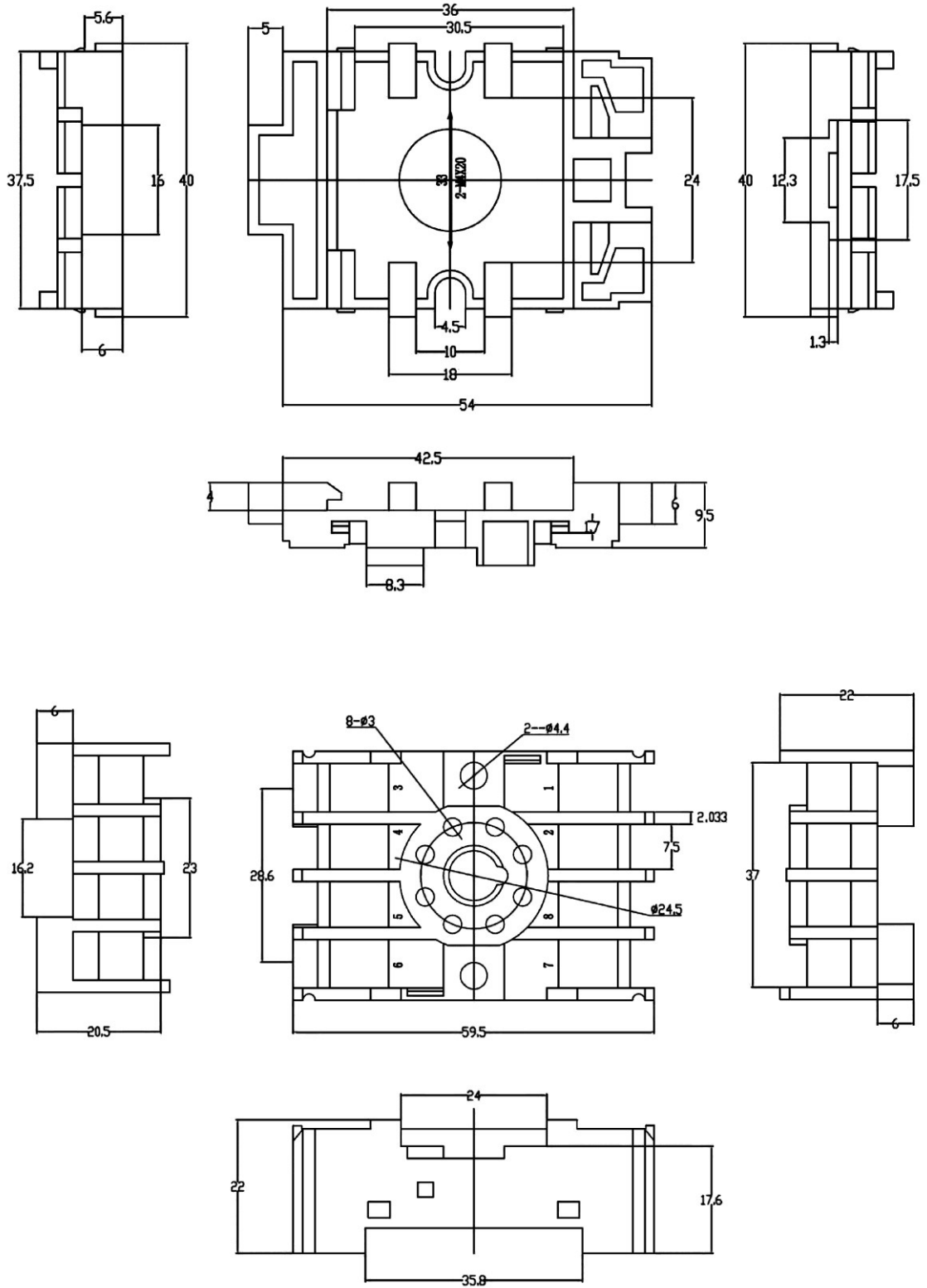

<KH-RS-R8>

### Appendix C: Electrical Drawings

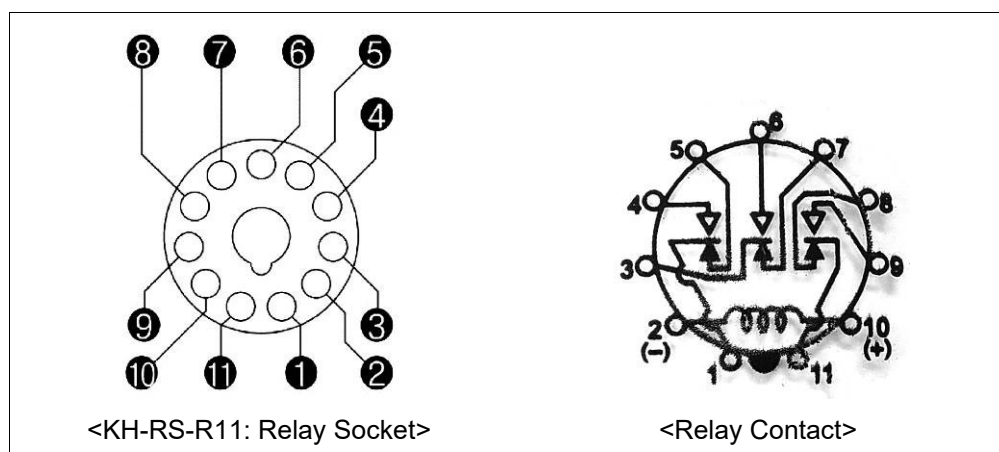
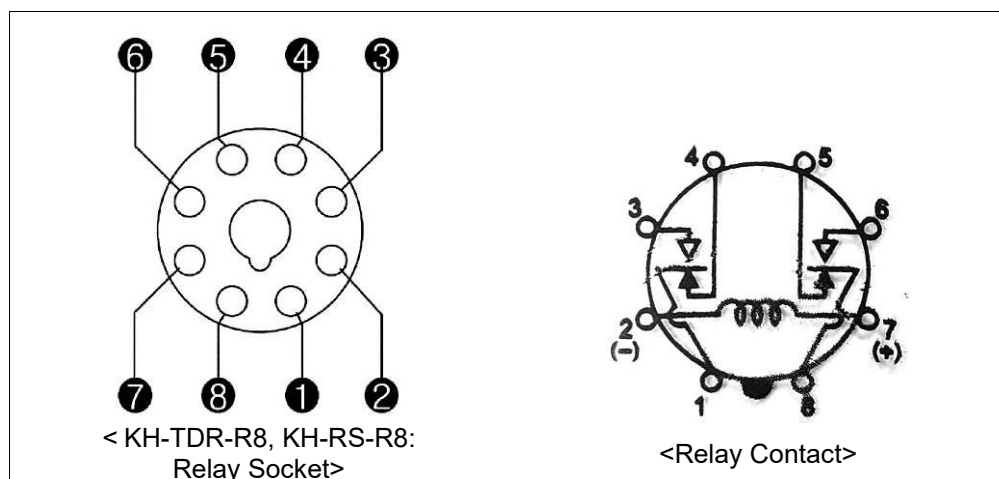
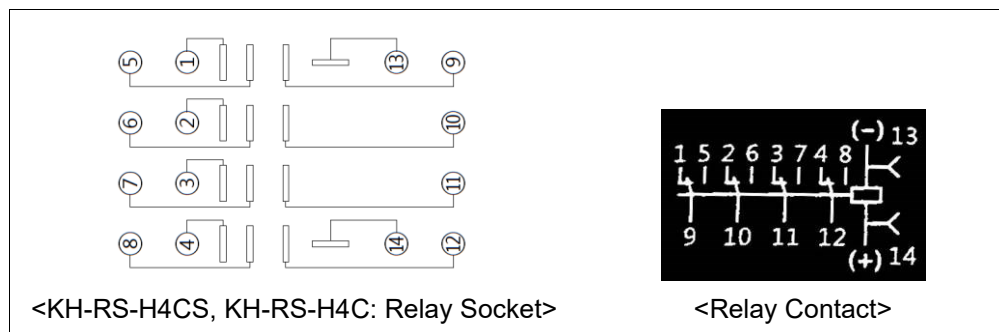

### Appendix D: Photos of Test Performance

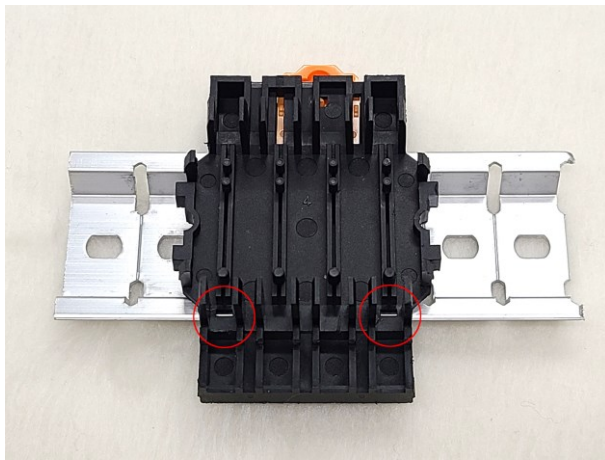

<Shortest spots: KH-RS-H4CS>



< Insulation distance: KH-RS-H4CS>

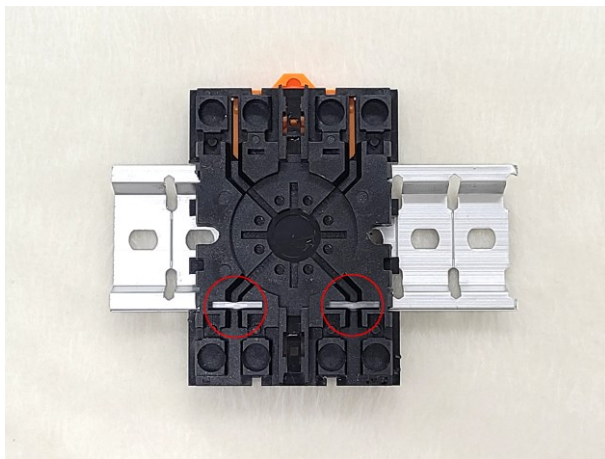

<Shortest spots: KH-RS-H4C>



<Insulation distance: KH-RS-H4C>



<Temperature rise test>

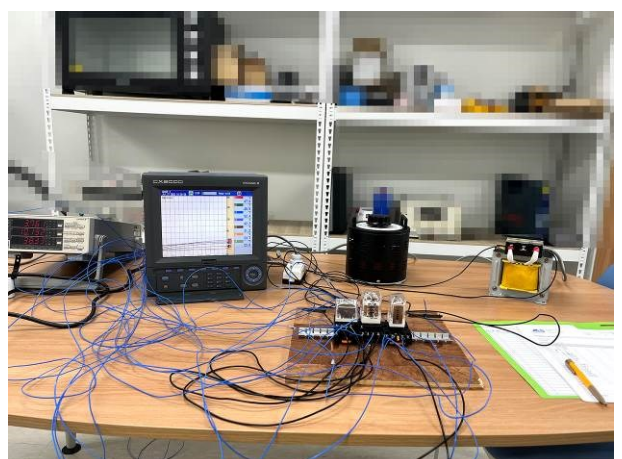

< Temperature rise test>





<Mechanical operation & contact resistance setting>

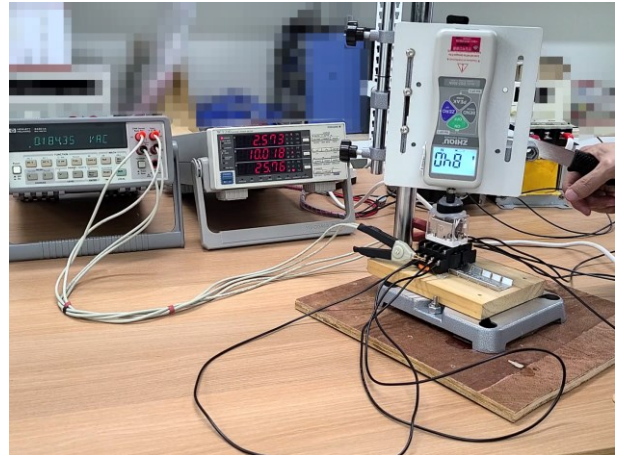

<Mechanical operation & contact resistance test>

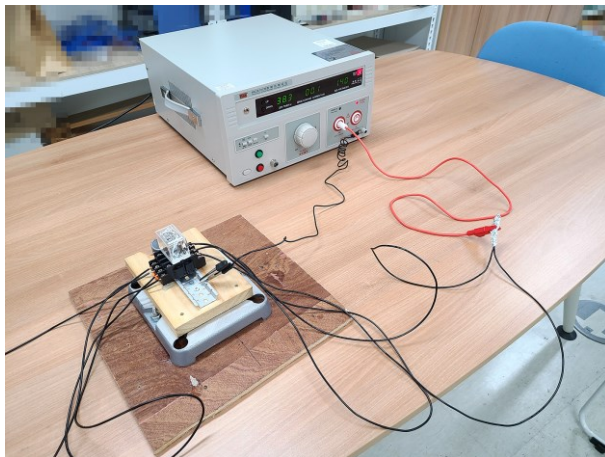

<Dielectric strength test>

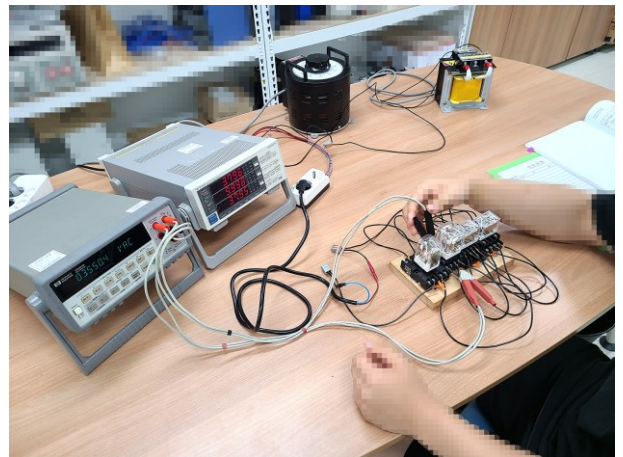

<Initial contact resistance before climatic test>



<2 hours of LLT condition at -15 °C>



<2 hours of LLT condition at -15 °C>





<7 days of ULT + 240 h of IEC 61810-1 requirement at 80 °C>



<Temperature measurement during 17 days at 80°C>



<Contact resistance after climatic test>

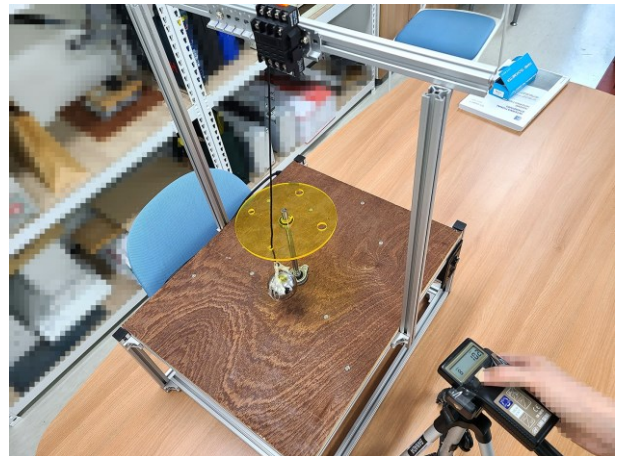

<Flexion test: 10 rpm>



<Flexion test for 14 minutes>



<Pulling out for 1 minute at 35 N>



<Ball-pressure test setup>



<Measured diameter: 0.82 mm>



<Glow-wire test: 750 °C setting>

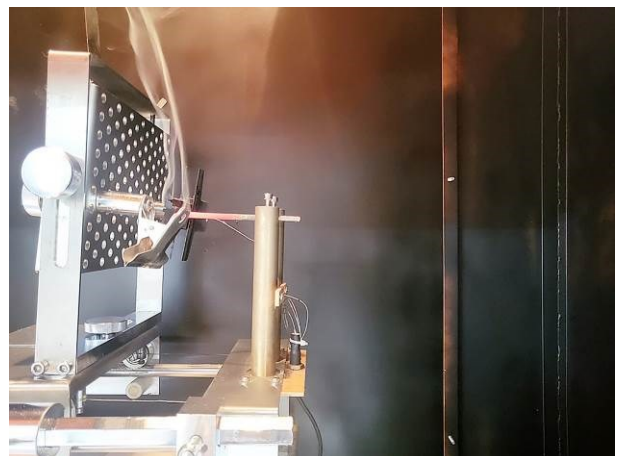

<Under glow wire test>



<EUT after test>



## Appendix E: List of test equipment used

Clause	Measurement / testing	Testing / measuring equipment / material used, (Equipment ID)	Range used	Last Calibration date	Calibration due date
IEC 60695-2-12	Glow Wire	Glow Wire Tester / REHOBOTH / RH15121A / 43-1(SLB)	(550-960) °C	2021-12-29	2022-06-29
7.3.11	Clearance and Creepage Distance	Calipers / SINCON / 20201125 / 14D	0-150mm/ 0.01mm	2022-01-20	2023-01-20
7.3.8	Temperature rise	1-phase Slide-ac	In: AC 220 V, 60 Hz, 1 kVA Out: AC 0-300 V, Max. 2 A	–	–
		Ground Continuity Tester (03B)	In: AC 220 V, 60 Hz, 500 VA Out: AC 10 V, 60 Hz, Max. 50 A	–	–
		Digital Power Meter / YOKOGAWA / WT210 / 05A	AC/DC 600 V, 20 A Function: V, A, PF, Hz	2022-01-22	2023-01-22
		Temperature Recorder / YOKOGAWA / CX2000 / 10A	k-type, 20-ch, resolution: 0.1 °C	2021-11-09	2022-11-09
IEC 60512 2b	Contact resistance	1-phase Slide-ac	In: AC 220 V, 60 Hz, 1 kVA Out: AC 0-300 V, Max. 2 A	–	–
		Ground Continuity Tester (03B)	In: AC 220 V, 60 Hz, 500 VA Out: AC 10 V, 60 Hz, Max. 50 A	–	–
		Digital Power Meter / YOKOGAWA / WT210 / 05A	AC/DC 600 V, 20 A Function: V, A, PF, Hz	2022-01-22	2023-01-22
		Digital Multimeter / H.P / 34401A / 6C	AC 0-10 V	2022-07-18	2023-07-18
7.3.12	Dielectric strength	Withstand Voltage Tester / Meiruike / RK2672CM / 08C	AC/DC 5 kV, 100 mA	2022-07-18	2023-07-18
7.3.9	Mechanical operation	Digital Push-Pull Gauge / Zhiqu / DS2-500N / 15B	500 N, resolution: 0.1 N	2022-01-18	2023-01-18
7.3.14	Corrosion test replaced by 14.4 of EN 61810-1	Electrical Oven / LDNS / L22-03 / 22B	60 L, temperature controller incorporated	–	–
		Temperature Recorder / YOKOGAWA / CX2000 / 10A	k-type, 20-ch, resolution: 0.1 °C	2021-11-09	2022-11-09
IEC 60695-10-2	Ball-pressure test	Ball-pressure Tester / Sunho / SH9104C / 22A	20 N, dia.=2.5mm	2022-01-24	2023-01-24
		Digital Microscope / CHDM / DM22-05 / 13E	x500, x1000	–	–
		Temperature Recorder / YOKOGAWA / CX2000 / 10A	k-type, 20-ch, resolution: 0.1 °C	2021-11-09	2022-11-09
8.2.4.3 of IEC 60999-1	Flexion test	Flexion Gig / LDNS / L22-02 / 23B	IEC 60999-1, Figure 1	–	–
		Tachometer / Line Seiki / TM-5010 / 19B	m/min, r/min	2022-08-29	2023-08-29

# 3. Leaflet (Ver.1.0)



## Leaflet for Relay Socket (ver.1.0)

1. Manufacturer: Kun Hung Electric Co., Ltd.
2. Model Names:



<KH-RS-H4CS>



<KH-RS-H4C>



<KH-TDR-R8>



<KH-RS-R11>



<KH-RS-R8>

3. Ratings: 10 A, 250 V, 50/60 Hz, IP00, without breaking capacity (COC)
4. No PE terminal is provided. For protection against electric shock, this relay socket can be installed in a metal enclosure such as an electric cabinet classified as Class I, but also in a Class II plastic enclosure.
5. Date of Manufacture: YYYY-MM-DD
6. Applied standard: EN 61984:2009 in conjunction with EN 61810-1:2020
7. Insulation voltage:  $U_i = 250$  V
8. Impulse withstand voltage:  $U_{imp} = 2.5$  kV
9. Overvoltage category: II
10. Pollution degree: 2
11. Ambient temperature: (0 ~ 40) °C
12. LLT-ULT: (-10 ~ +80) °C
13. Connectable Conductor: Flexible or stranded insulation wire with range of (0.75–1–1.5) mm<sup>2</sup> or (20–18–16) AWG
14. This relay socket should be directly fixed in accordance with the dimension or fixing specification or mounted on a normal DIN rail in an electrical cabinet.
15. Altitude for installation and use shall be lower than 2 000 m.
16. Precautions for installation
  - A. Allowable terminal temperature rise: up to 45 K.
  - B. Mounting type: Group mounting (A)
  - C. Overcurrent protective device rated as T16AL250V must be installed together with relay contacts.

17. Terminal identification:

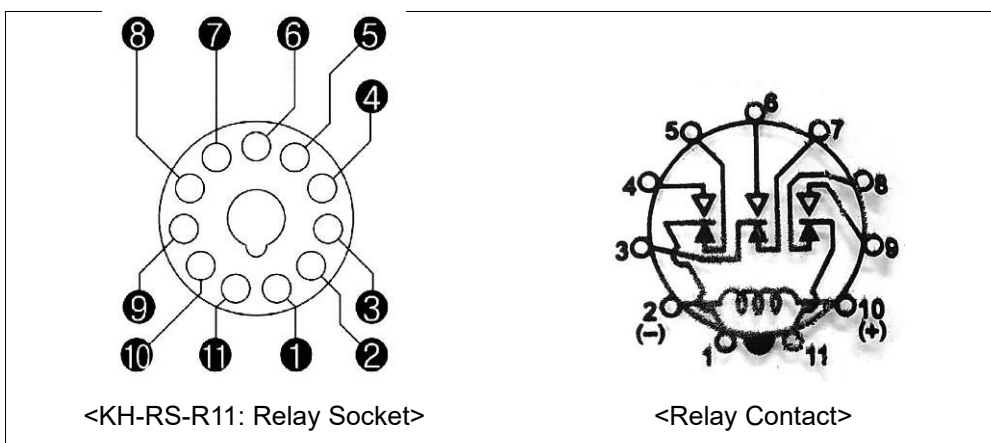
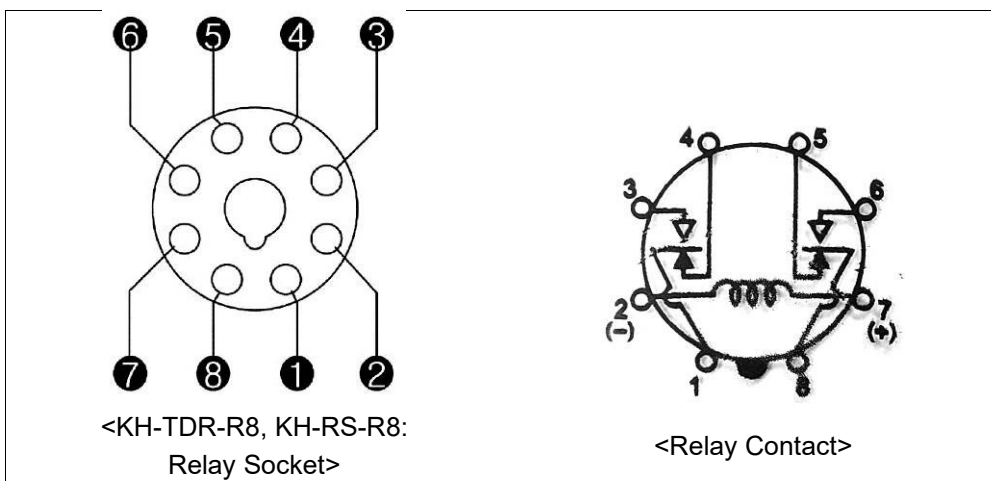
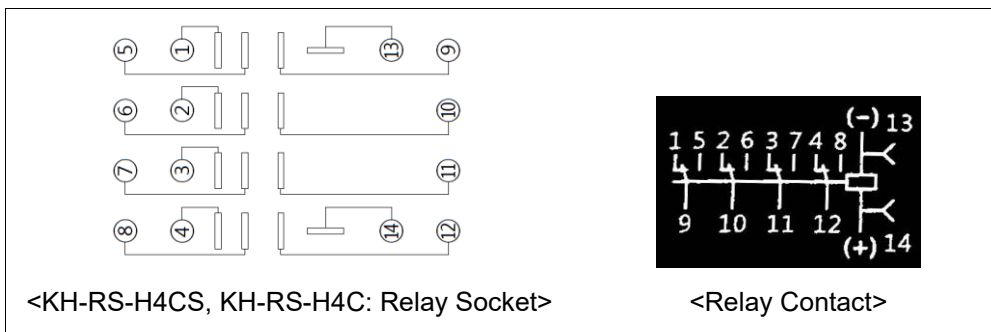

18. It is highly recommended that the relay socket is used together with KOINO's relay.

19. Dimension:

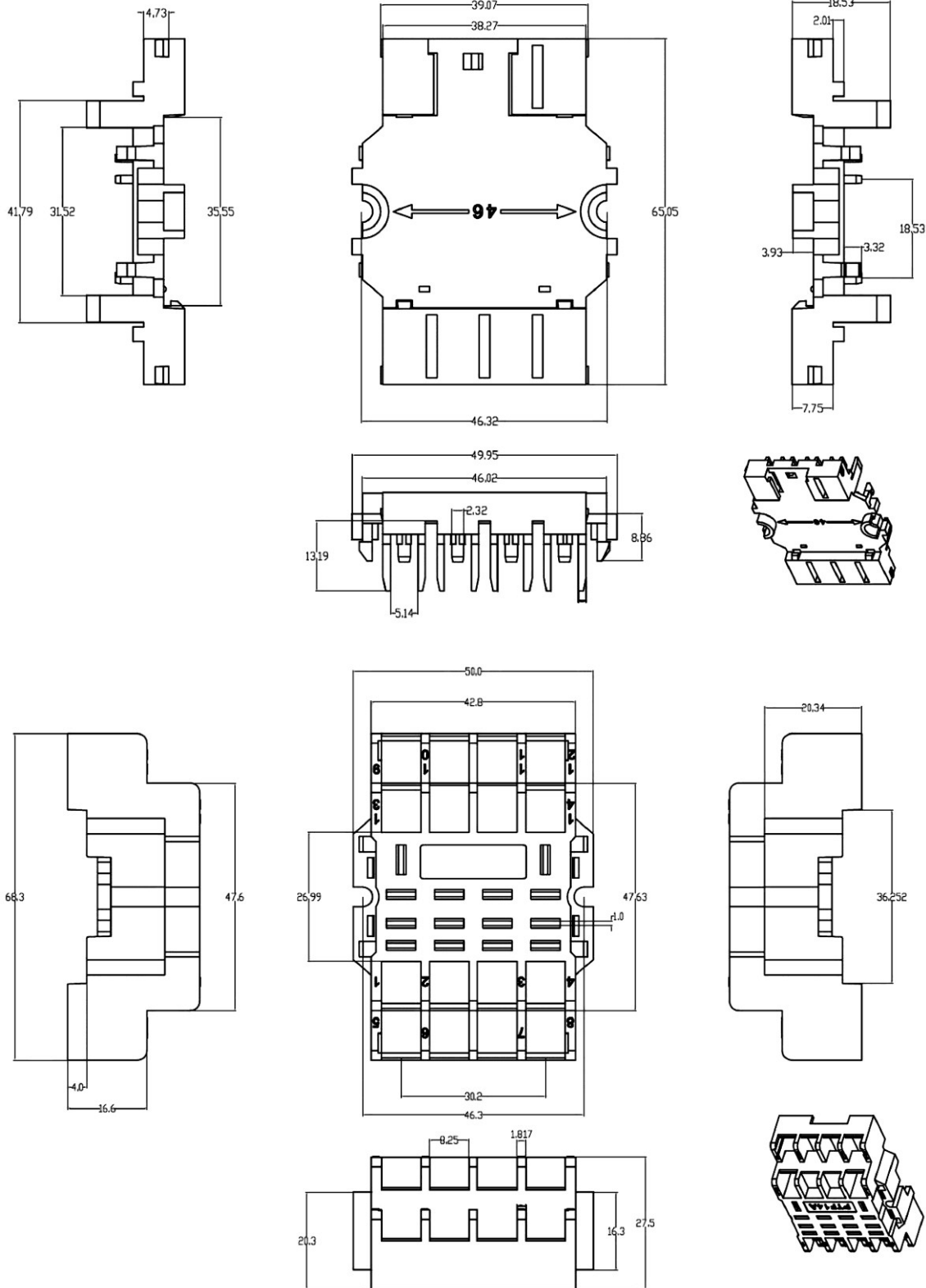

<KH-RS-H4CS>

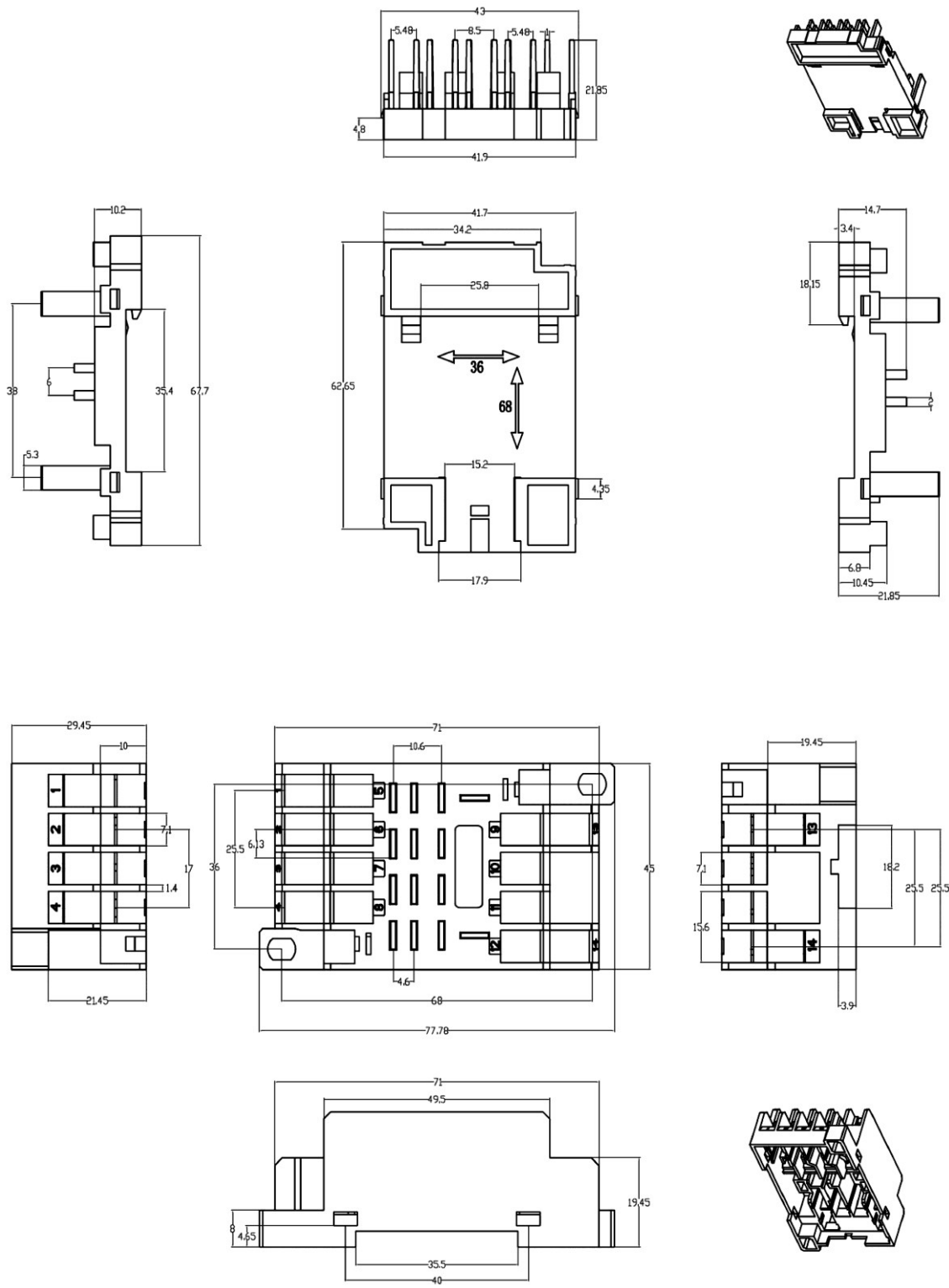

<KH-RS-H4C>

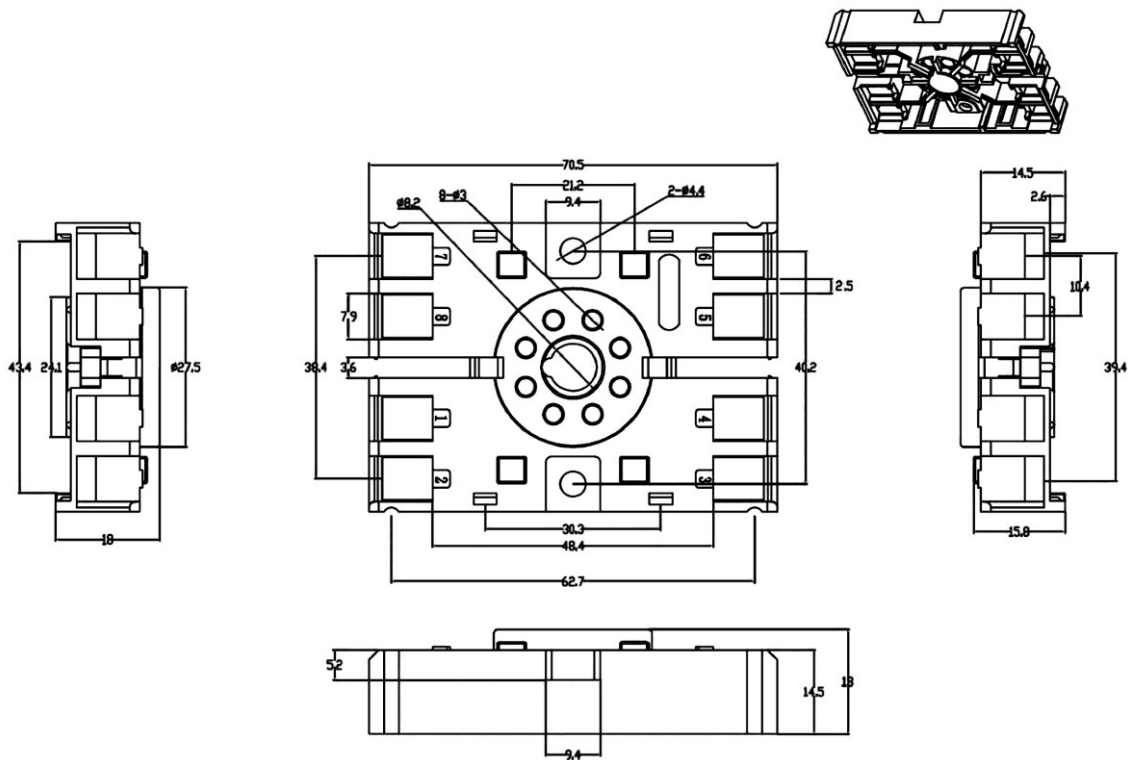
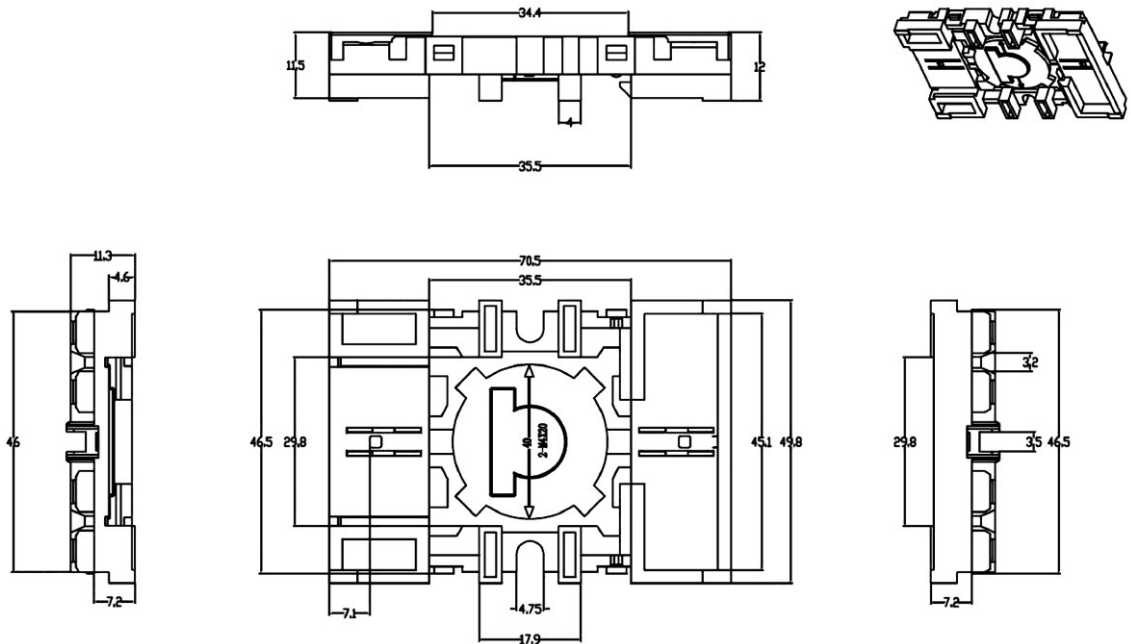

<KH-TDR-R8>

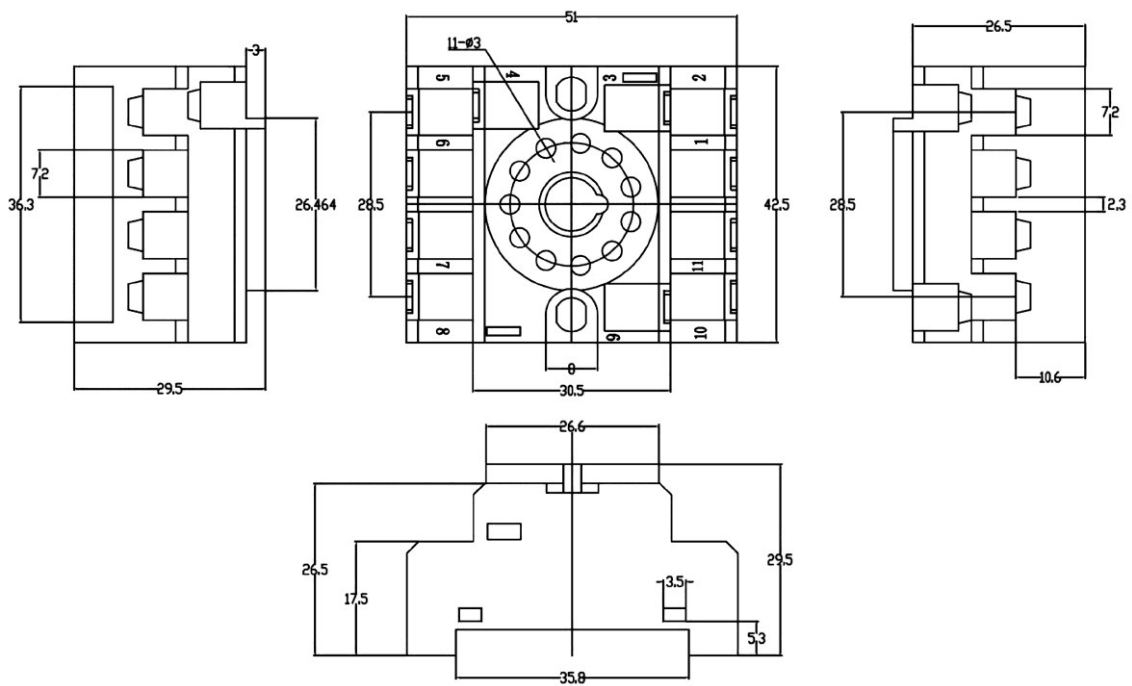
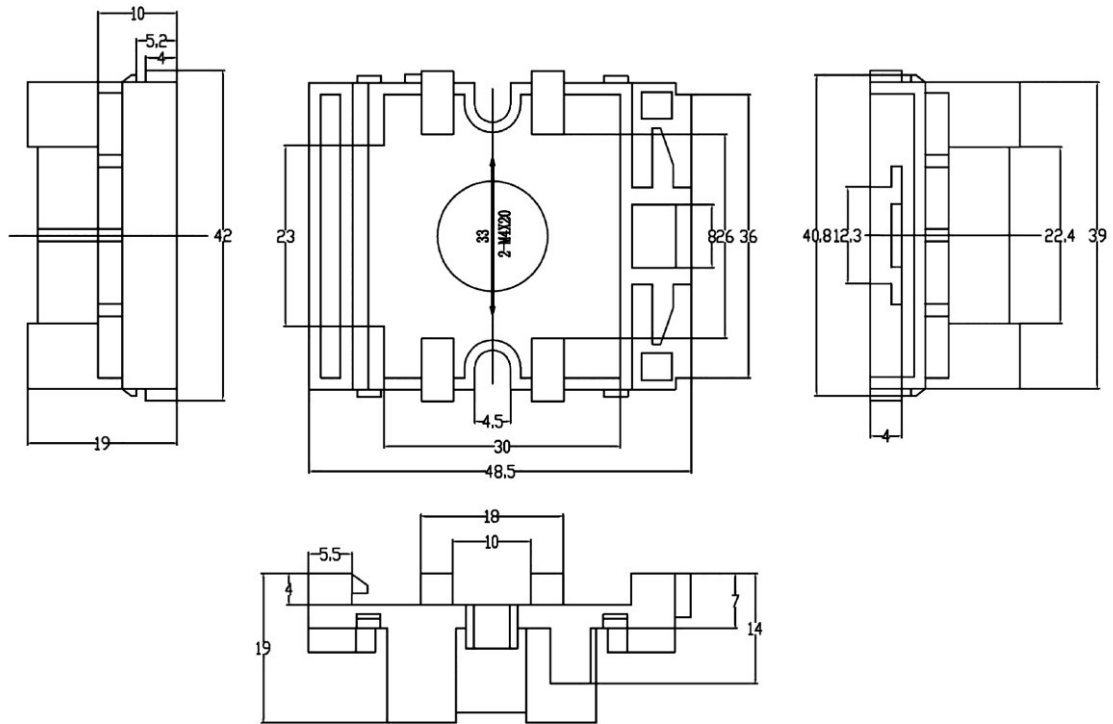

<KH-RS-R11>

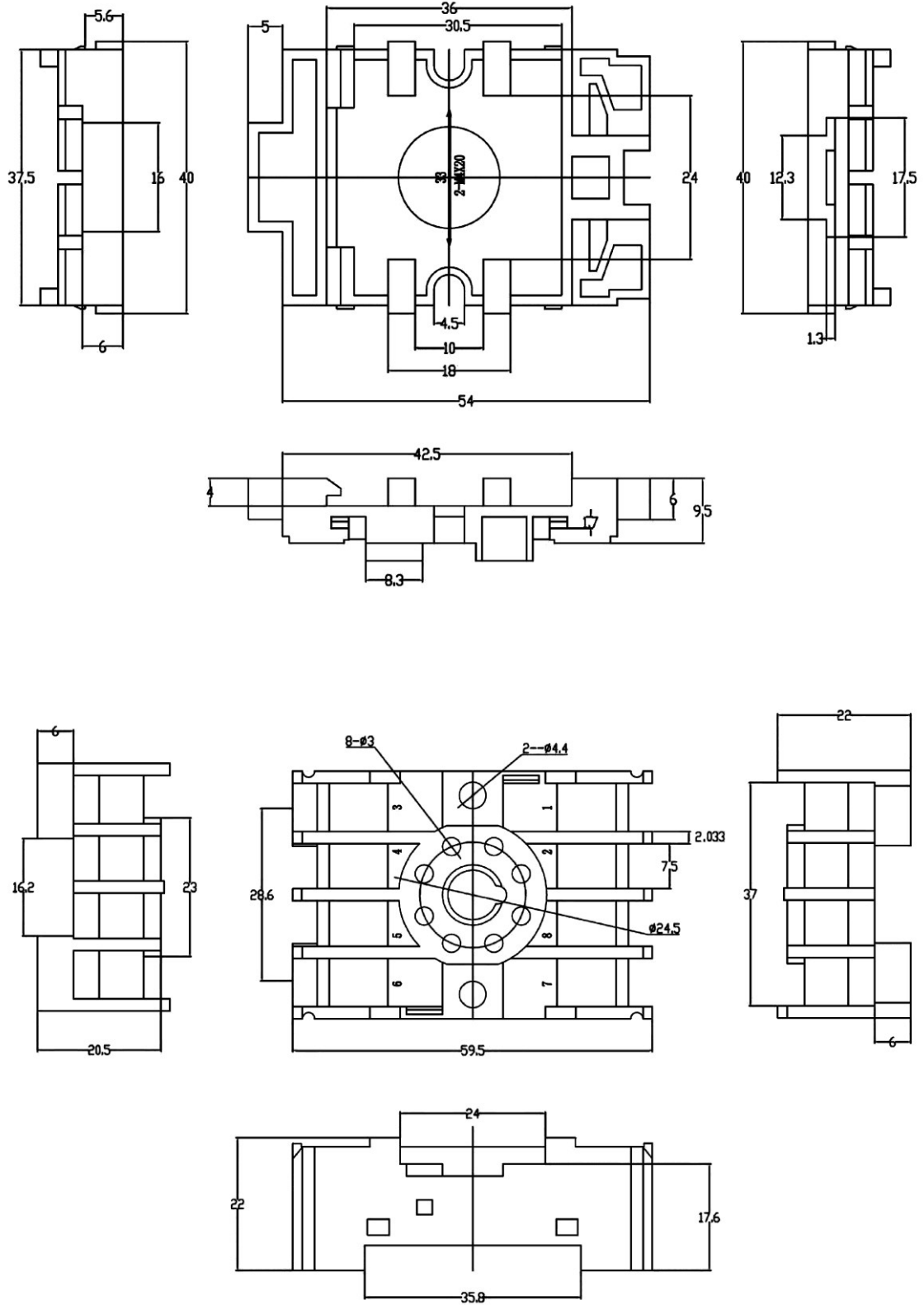

<KH-RS-R8>



20. Marking Plates:





# 4. Drawing

## A. Electrical Drawing

See the Appendix C of the test report of LR-22-C008.

## B. Mechanical Drawing

See the Appendix D of the test report of LR-22-C008.

# 5. Critical components & their Certificate

## A. Critical Components

Object/part No.	Manufacturer / trademark	Type/model	Technical data	Standard (Edition / year)	Mark(s) of conformity
Relay Base	CGN Juner New Materials Co.,Ltd.	PA-A6-2	PA6, Min. thk.0.8 mm, V-2	IEC 60695-11-10	UL (E204321)
			GWFI: Min. thk. 1.5mm, 750 °C	IEC 60695-2-12	Tested in EUT; see TABLE 0.3.2
			Ball-pressure at 125 °C	IEC 60695-10-2	Tested in EUT; see TABLE 0.3.3
Supplementary information:					

## B. Certificates

**PROSPECTOR®**

[CLICK TO CONTINUE](#)

The information presented on the UL Prospector datasheet was acquired by UL Prospector from the producer of the material. UL Prospector makes substantial efforts to assure the accuracy of this data. However, UL Prospector assumes no responsibility for the data values and strongly encourages that upon final material selection, data points are validated with the material supplier.

Component - Plastics

E204321

Guide Information

### CGN JUNER NEW MATERIALS CO.,LTD.

No.339 Jinhai Avenue, Wenzhou Economic and, Technological Development Zone, WENZHOU ZHEJIANG 325001 CN

### PA-A6-2

Polyamide 6 (PA6), furnished as pellets

Color	Min_Thk (mm)	Flame Class	HWI	HAI	RTI Elec	RTI Imp	RTI Str
ALL	0.8	V-2	4	-	65	65	65
	3.0	V-2	3	-	65	65	65

Comparative Tracking Index (CTI): 1

Inclined Plane Tracking (IPT) kV: -

Dielectric Strength (kV/mm): -

Volume Resistivity (10<sup>x</sup> ohm-cm): -

High-Voltage Arc Tracking Rate (HVTR): -

Surface Resistivity (10<sup>x</sup> ohms/square): -

Dimensional Change (%): -

High Volt, Low Current Arc Resis (D495): -

ANSI/UL 94 small-scale test data does not pertain to building materials, furnishings and related contents. ANSI/UL 94 small-scale test data is intended solely for determining the flammability of plastic materials used in the components and parts of end-product devices and appliances, where the acceptability of the combination is determined by UL.

Report Date: 2000-11-06

Last Revised: 2006-07-12

© 2022 UL LLC



### IEC and ISO Test Methods

Test Name	Test Method	Units	Thk (mm)	Value
Flammability	IEC 60695-11-10	Class (color)	0.8	V-2 (ALL)
			3.0	V-2 (ALL)
Glow-Wire Flammability (GWFI)	IEC 60695-2-12	°C	-	-
Glow-Wire Ignition (GWIT)	IEC 60695-2-13	°C	-	-
IEC Comparative Tracking Index	IEC 60112	Volts (Max)	-	-
IEC Ball Pressure	IEC 60695-10-2	°C	-	-
ISO Heat Deflection (1.80 MPa)	ISO 75-2	°C	-	-
ISO Tensile Strength	ISO 527-2	MPa	-	-
ISO Flexural Strength	ISO 178	MPa	-	-
ISO Tensile Impact	ISO 8256	kJ/m <sup>2</sup>	-	-
ISO Izod Impact	ISO 180	kJ/m <sup>2</sup>	-	-
ISO Charpy Impact	ISO 179-1	kJ/m <sup>2</sup>	-	-